

DYNAMIC EVALUATION OF LASER TRACKERS

by

Victoria Welty

A thesis submitted to the faculty of
The University of North Carolina at Charlotte
in partial fulfillment of the requirements
for the degree of Master of Science in
Mechanical Engineering

Charlotte

2015

Approved by:

Dr. Edward Morse

Dr. Jimmie Miller

Dr.-Ing. Freidrich Goch

ABSTRACT

VICTORIA WELTY. Dynamic evaluation of laser trackers. (Under the direction of DR. EDWARD P. MORSE)

This thesis details the development, performance, and analysis of tests for the dynamic performance evaluation for laser trackers. Laser trackers are large-scale measuring systems that utilize a spherical coordinate system for measurement. These systems are capable of measurement in both static and dynamic modes, but both national and international standards for performance evaluation of these instruments only addresses static measurement. The purpose of this work is to develop standard methods to evaluate the performance of a laser tracker's dynamic measurement capabilities.

Experiments were developed and carried out to both compare trackers and to provide a basis for the quantitative statement of performance capabilities. Three laser trackers, all from different manufacturers, were evaluated to demonstrate the variation from tracker to tracker. These test setups used precision equipment and artifacts to establish a basis for comparison, so that errors of measurement could be reported with limited uncertainty, in addition to repeatability. Different parameters, such as the speed of the target, the angular velocity of the tracker head, the distance from the tracker to the target, and interaction of the three tracker axes were varied to study their impact on the accuracy of tracker measurements. The variables with significant impact were identified and the results were used to develop a suggestion for a standard evaluation procedure.

Trends were observed of increased error with increased angular velocity at the tracker head as well as scanning configurations that require the most interaction between the azimuth and elevation axes of the tracker.

ACKNOWLEDGMENTS

I would like to acknowledge the support I received throughout the process of completing this thesis. First, I would like to thank Dr. Edward P. Morse for his input and patience over the past few years. Without his help and encouragement, I would not have reached the conclusion of this work. I would also like to thank the UNC Charlotte Center for Precision Metrology and its affiliates for funding the research behind this thesis and making it possible for me to continue my education. I would also like to thank my committee, Dr. Jimmie Miller and Dr. Freidrich Goch, for their input and support. I am also very grateful for the time Matt Bellasai who dedicated a summer to helping to develop one evaluation method. Lastly, I would like to express my appreciation to my family and friends for their support throughout my college career.

TABLE OF CONTENTS

CHAPTER 1: INTRODUCTION	1
1.2 Current Tracker Capabilities and Standards	4
1.3 Tracker-Specific Vocabulary	5
1.4 Problem Statement	6
1.5 Structure of this Thesis	6
CHAPTER 2: LITERATURE REVIEW	7
CHAPTER 3: EXPERIMENTAL VARIABLES AND CONSIDERATION	12
3.1 UNC Charlotte Laser Trackers	12
3.2 Spatial Analyzer	14
3.3 Variables for Evaluation	14
3.3.1 SMR Speed	14
3.3.2 Distance from SMR to Tracker	15
3.3.3 Isolations of Tracker Axes and Encoder Interaction	15
3.4 Considerations for Test Procedures	16
3.4.1 Environment	16
3.4.2 Tracker Calibration	17
3.4.3 System Stability	17
3.4.4 Software Settings	17
3.4.5 Additional Hardware	18

3.4.5 Human Error	18
CHAPTER 4: SURFACE PLATE EVALUATION	19
4.1 Introduction	19
4.2 Equipment	19
4.3 Setup	19
4.4 Procedure	21
4.5 Data and Analysis	22
CHAPTER 5: ROTATING BALL BAR EVALUATION	25
5.1 Introduction	25
5.2 Equipment	25
5.2.1 Rotating Ball Bar Setup	26
5.2.2 Labview Interface	27
5.3 Setup	28
5.4 Procedure	29
5.5 Data and Analysis	29
CHAPTER 6: PRECISION SLIDE EXPERIMENT	34
6.1 Introduction	34
6.2 Equipment	34
6.2.1 Precision Slide	34
6.3 Tracker Orientations	36

6.3.1 Azimuth Isolation	36
6.3.2 Elevation Isolation	36
6.3.3 Encoder Combination	37
6.3.4 Ranging Isolation	38
6.4 Procedure	39
6.5 Data and Analysis	39
6.5.1 Synchronization	39
6.5.2 Geometric Deviation	48
CHAPTER 7: ARTIFACT SCAN	53
7.1 Introduction	53
7.2 Equipment	53
7.3 Setup	53
7.4 Procedure	54
7.5 Data and Analysis	55
7.5.1 Scanned Features	55
7.5.2 Static Point Fit	55
7.5.3 Dynamic Scan Fit	56
7.5.4 Nominal Data from ATOS Scanner	57
7.5.6 Comparison	58
CHAPTER 8: CONCLUSIONS AND FUTURE WORK	59

8.1 Discussion of Evaluation Variables	59
8.1.1 SMR Speed	59
8.1.2 Distance from SMR to Tracker	59
8.1.3 Isolations of Tracker Axes	60
8.2 Comparison of Results	60
8.2.1 Individual Tracker Conclusions	60
8.2.2 Tracker to Tracker Comparisons	60
8.3 Additional Considerations	61
CHAPTER 9: RECOMMENDATIONS FOR REVISION TO STANDARD	62
9.1 Current Standard	62
9.2 Recommendations	62
9.2.1 Ranging Axis	62
9.2.3 Rotational Velocity	63
9.2.3 Artifact Scan	64
9.2.4 General Guidelines for Testing	64
REFERENCES	66

CHAPTER 1: INTRODUCTION

Laser trackers are one of the more recent developments in measurement systems, utilizing precision motion and optics to take highly accurate measurements. The laser tracker was first conceptualized by K. Lau and R.J. Hocken as a solution to tracking the location of a robot in space (Lau, Hocken and Haight 1986). Since the origination of laser trackers, they have quickly become an economically feasible option for measurement in a broad range of manufacturing settings. Trackers have been improved over time to reduce cost, increase portability and facilitate the increase of measurement speed, while attempting to retain the integrity of the measurement.

Standards such as ASME B89.4.19-2006 (American Society of Mechanical Engineers 2006) outline methods to evaluate the accuracy of specific functionality of trackers however, the specific test methods do not address the dynamic capabilities.

1.1 Laser Tracker Introduction

A laser tracker is a laser-based, spherical coordinate measurement system (American Society of Mechanical Engineers 2006), as the coordinate locations are determined by a distance and two angles measured from an origin. The distance value is established using absolute distance measurement or interferometry, depending on the system and settings. Interferometry mode, or IFM, uses a standard interferometer and helium-neon laser to determine the distance from the head to the target. Two lasers are shot from the tracker head, one directly into the sensor and one that travels out of the sensor and to the target

then returns back to the sensor. The wave patterns of the two beams interfere and the interference, or “fringe counts”, are counted by circuitry in the sensor. The patterns are calibrated using a known home location, called the “birdbath”, that is located on the tracker. Absolute distance measurement, or ADM, is a newer approach to distance measurement using the flight time of the laser to determine distance. ADM allows the user to scan without returning to the birdbath, even if the beam is broken, where the IFM must be re-zeroed to the home position before continuing. Using ADM provides the advantage of being able to stay at a distance if the beam is broken, where the IFM can be tedious to return to the tracker and re-zero each time. The azimuth and elevation measurements are provided by encoders that report the rotary motion of the tracker head about two mutually orthogonal axes. (Bridges 2009) For better understanding, Figure 1 and Figure 2 are included below.

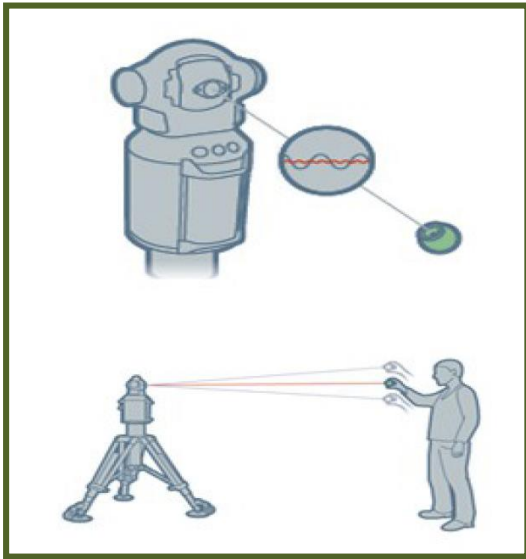

Figure 1: Demonstration of the basic operation of a laser tracker (Bridges 2009)

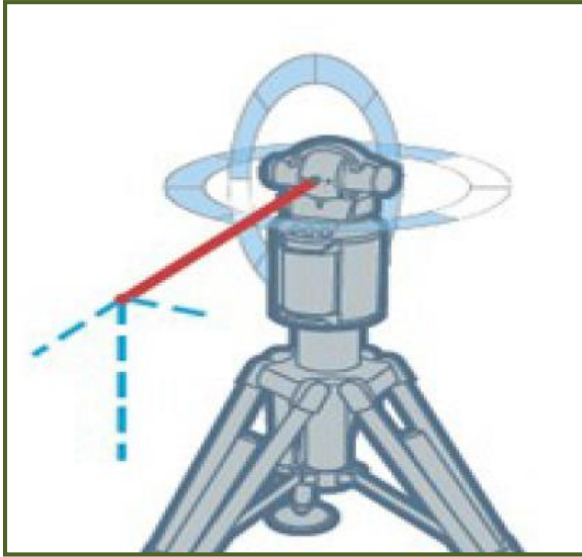

Figure 2: Representation of a coordinate system and the three axes of a tracker (Bridges 2009)

Trackers function by following any cooperative target, or object that returns a signal, the spherically mounted retroreflector (SMR) being the most common of these, with a laser. The SMR is a cube corner mirror, precision mounted to the center of a precision sphere generally within 2-20 micrometers uncertainty from both form and center alignment. An example of an SMR is shown in Figure 3. The apex of the mirrored cube corner is tracked by the laser tracker, which is nominally coincident with the sphere surface. Settings in the software allow for the SMR center data to be corrected to the point of contact between the spherical surface and the object being measured.

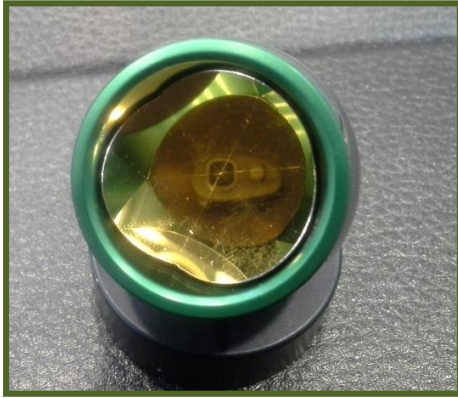

Figure 3: A spherically mounted retroreflector

The tracker will follow the SMR as long as the laser has a direct line of sight to the mirror and it is returning the laser to the tracker head. The tracker determines the offset of the beam to the center of the cube corner. When the offset is returned at zero, the tracker determines it as the location of the coordinate. As the offset increases, the tracker rotates to correct the location to the center of the SMR. Trackers vary in behavior when the beam is broken, ranging from automatically locating the lost target and recalibrating the distance to requiring a manual relocation and a homing sequence to ensure a comparable distance.

Trackers are widely used in large scale manufacturing environments because of the portability and long-range capabilities. As the trackers evolve, more and more uses become viable options, presenting the possibility to simplify measurement procedures and reduce process length.

1.2 Current Tracker Capabilities and Standards

The most time-tested use of trackers is a point to point static measurement style. The SMR is placed in a nest and the software is triggered to take a reading of the point based on the average of a sample set of a predetermined number of measurements, often 100 or

more. For ease of use, software has also allowed for points to be taken at each point where the SMR remains stable.

As trackers have evolved, so has the software. The speed and functional stability of the tracker has opened the door to extensive capabilities. The dynamic capabilities of the trackers are not currently well-explored but have great potential to be an asset to measurement scenarios. The ability to scan and gather dense data sets in three dimensions on a large scale is a promising development.

One important concern with new functionality is the lack of a standardized method to verify the accuracy of the measurements. Currently, the standard that trackers are evaluated by includes the point to point, static measurements but provides no way to determine the accuracy of the tracker when measuring in motion.

1.3 Tracker-Specific Vocabulary

ADM – absolute distance mode; ranging axis mode using the flight time of the laser to determine the distance from the tracker to the target

Azimuth – axis specific to the horizontal rotation of the tracker head

Birdbath – homing position for the interferometry mode the tracker uses for range built directly in the tracker; the distance to the SMR in the birdbath is known to the tracker and used to zero the interferometer

Elevation – axis specific to the vertical rotation of the tracker head

IFM – interferometry mode; ranging axis mode using “fringe patterns” from two lasers and a home position to determine the distance from the tracker to the target

Ranging – axis specific to determining the distance from the tracker to the target; ranging carried out in either interferometry mode or absolute distance mode

SMR – Spherically mounted retroreflector; a type of cooperative target consisting of a cube-corner mirror mounted in a spherical housing; SMRs can come in various sizes and are certified to size by the manufacturer

Two-face test – compensation sequence performed to correct for error in data processing; three to five locations are taken first at the front face then the head is reversed and the measurement is taken at the other face and the locations are evaluated for deviation, giving a value to input for software compensation

1.4 Problem Statement

The goal of this thesis is to use various test setups and evaluation methods to determine what variables affect the accuracy significantly and to refine these test and evaluation methods into an evaluation procedure suitable for a revision to the current standard. Using the precision equipment available and the three trackers owned by the University of North Carolina at Charlotte, test procedures were designed and refined to isolate sources of error and evaluate them with some quantitative comparison.

1.5 Structure of this Thesis

Following this introductory section, a review of relevant literature is presented in Chapter 2. Chapter 3 discusses details regarding variables being considered to evaluate the trackers in the tests that follow. Chapters 4, 5, 6, and 7 provide the details of specific testing protocols and results from the experimental testing done to establish ideas as a basis for a standard. Chapter 8 outlines some of the conclusions from the testing as well as further investigation that is recommended for the topic. Finally, Chapter 9 provides recommendations for the update of the current standards for laser trackers to include the evaluation of the dynamic functionality of the trackers.

CHAPTER 2: LITERATURE REVIEW

Since their conception in 1986, laser trackers have become a more commonly used tool in a variety of applications. Due to the increased use as well as competitive manufactures of laser trackers, there is a large amount of information available about the technology. The following is the compilation of literature that was found and applied in the development of this thesis.

The first document to mention is the paper that outlined the concept for laser trackers. “Automatic laser tracking interferometer system for robot metrology” written by K. Lau, R Hocken and W.C. Haight (Lau, Hocken and Haight 1986). The paper states the increase in the need for robotic accuracy in a growing number of automation applications fueled the need for a system capable of locating the working origin of the robots as they articulate. The paper illustrates the design and mathematical principles behind the initial tracker design. Factors for uncertainty are also discussed. Looking at the initial design concepts provides insight on the development of the tracker to present day. Factors such as beam bending and accurate alignment are noted as significant concerns effecting the accuracy of the system. Since this initial concept, the alignment of the beam has been addressed in the following iterations. The angular pointing capability has also been considered in the designs. Though the effect these factors have been limited by the design, they may not have been entirely eliminated. Beam bending errors due to

environmental change is always a factor and is as significant to testing in present design as it was as origination.

Paul Tullar, John Grant, and John Patten, led by Robert Hocken follow up the previous paper in 1990 with “Error Modeling and Correction of a Laser Tracker” (Tullar, et al. 1990). Students under Hocken’s direction investigated an early model of the laser tracker. Experiments were carried out to look at the errors occurring in that particular tracker. A long list of error sources is provided and experiments are developed to address them. The tracker they are working with is very outdated and many of the error sources have been addressed through design iterations and software development, but the approach used toward determining relevant testing setups is useful when considering new standards.

The next paper, in contrast, is a review paper written in 2002 called “Large-Scale Metrology – An Update” written by W. T. Estler and associates (Estler, et al. 2002). The review covers multiple options and technological advancements for metrology in terms of large-scale application. Among the technologies noted, the laser tracker is addressed in some detail. Principles behind the operation of the tracker are explained with a section specific to performance testing. The difficulty of axis isolation, scale errors, and the difficulty of comparison to a device with a higher accuracy rating are stated as factors in the development of the static evaluation standard and should also be noted for dynamic testing. Another applicable topic discussed is the ability of a frameless measurement system to “self-calibrate” mathematically. When considering variables, it is valuable to know how the software is processing the data after collection. Absolute distance measurement (ADM) is also detailed, giving perspective on the functionality of ADM

versus interferometry when evaluating the ranging axis. Tooling limitations are also noted for consideration.

“Research of measuring accuracy of laser tracker systems” investigates the effects of time and temperature on the accuracy of the system (Jianfei, et al. 2006). To evaluate the effect of time, the tracker repeats measurements at regular intervals over 14 hours. The conclusion reached is that the system does not stabilize until it has been warmed up 3 hours and stability declines after 10 hours. A second investigation shows the optimal temperature range for the tracker to be between 20°C and 23.8°C. The conclusions made are certainly appropriate for the data presented, however only one model of tracker is addressed.

A method was written in “The case for a constant method of verifying the performance of large volume measurement systems” to address the challenges associated with measuring on a large scale (Clark, et al. 2000). When working with large-scale systems, they do not follow the well-established path developed for the CMM. Laser trackers are discussed alongside photogrammetry and portable arm CMM because they all exhibit challenging characteristics. Issues associated with standard development, such as practicality, confidence, and others are presented as important issues for the development of the standard. The paper continues to lay out a test procedure using an artifact and static measurement to evaluate each sensor individually. The paper includes methods for the two rotary axes as well as both ADM and IFM functions across the entire range of the tracker. Isolating the axes for evaluation, as well as methodically combining them using the angle of the artifact, can characterize the error for each component as well as the tracker a whole. Though these measurements were done statically, the same

isolation concept and range evaluation should be used when evaluating the dynamic capabilities as well.

Calkins and Salerno discuss uncertainty in a different light in “A Practical Method for Evaluating Measurement System Uncertainty” (Calkins and Salerno, PhD 2000). The methods discussed in the paper are directed toward determining the accuracy of the tracker in the intended measuring environment. By approaching the evaluation in a location and application specific context, the user is given an uncertainty value that is relevant to the regular use. While certifying a system at the time of manufacture can provide an ideal uncertainty value, obtaining a more applicable evaluation can be more important to the user. Evaluating the tracker in the user setting also allows for the system to be defined by the user based on the equipment specific to the individual installation of the tracker. By using these evaluation methods the user is including not only the environmental characteristics, but also common user behavior and unique equipment configurations. When considering a standardized procedure, consideration should be taken for the definition of the system, as it is essential to the understanding of certification values.

One of the most important documents to be aware of is the ASME standard for laser tracker evaluation, ASME B89.4.19 (American Society of Mechanical Engineers 2006). The standard addresses all factors decided upon by ASME in terms of laser trackers. Guidelines for measurement techniques and environment are specified first, then artifact measurements are detailed. The measurements are done using nests and static artifacts to take specific length measurements. The standard also includes some recommendations for SMR evaluation. The current standard is a static setup that is performed using a point

to point measurement. While these methods are relevant to the static function of the tracker, they cannot be directly applied to the dynamic capabilities of the tracker. Using the principles and guidelines from the standard, it needs adapted to accommodate for the developing scanning application evaluation.

CHAPTER 3: EXPERIMENTAL VARIABLES AND CONSIDERATION

3.1 UNC Charlotte Laser Trackers

The University of North Carolina at Charlotte owns three trackers from three different manufacturers. The trackers are shown below. The three trackers have some distinct characteristics despite their similar functionality. The Leica Absolute Tracker, seen in Figure 4 is the largest of the three trackers, yet has the smallest volume of parts in motion during measurement. The FARO Ion tracker, below in Figure 5, is the midsized tracker, most similar in design to the Leica, with a sturdy body and a rotating head. The major difference in the designs is the aiming mechanism for the laser. The Leica uses a steering mirror to direct the beam while the FARO aims the laser directly from the head, using the motion of the rotary axes to direct the lasers. The third tracker is the API T3, seen in Figure 6. The API is the most compact, portable option of the three. The compact design eliminates a stationary body and rotates the entire mass of the system for measurement. The laser in the API functions like the FARO, aiming directly from the head. While the API is the smallest of the three, the size of the rotating parts is largest in this system.



Figure 4: Leica Absolute Tracker



Figure 5: FARO Ion



Figure 6: API T3

3.2 Spatial Analyzer

The software used in all test procedures is Spatial Analyzer Professional 2013.03.22 from New River Kinematics. The software allows for all three trackers to be used with the same settings as well as simultaneously. Spatial Analyzer automatically filters the data as directed and can fit data to shapes for processing. Further capabilities of the software that were utilized will be detailed in later discussion.

3.3 Variables for Evaluation

Before procedures can be decided upon for recommendation, the significant variable of the dynamic scanning function must be identified. The primary variables to be examined were speed, distance, and isolated axes.

3.3.1 SMR Speed

The speed of the SMR influences the speed of the tracker head and, depending on the setting, the data collection rate. By increasing the speed of the SMR, the tracker axes are forced to keep up by increasing the speed of rotation when the line of motion operates in

one or both the elevation and/or the azimuth direction. In other words, when the target's line of travel is not exclusively along the ranging axis, the trackers use of precision motion and encoders could impact the precision of the measurement.

3.3.2 Distance from SMR to Tracker

The tracker is widely useful due to the range capabilities but the range may have a significant effect on the data. The only setback in this axis is the reliance primarily on the laser functionality. The major factor that affects the precision of the interferometer or absolute distance measurement is the environment. Air conditions, such as particulates, humidity and pressure as well as temperature variation become significant when discussing lasers. The index of refraction of the air must be considered and should be constant throughout the range of measurement. Any gradients in air quality and temperature can cause beam bending and error. A clean room environment is the best option for any laser-based measurement and any deviation from this should be noted in a measurement requiring a degree of accuracy close to the certification of the tracker. It may be beneficial to approach the ranging factor on a case by case basis rather than the tracker itself. The angle of motion of the tracker head is also reduced and may affect the precision of the measurement. The range of the tracker in angular motion has an effect on the range of motion in the tracker head and could influence the error range.

3.3.3 Isolations of Tracker Axes and Encoder Interaction

Each of the tracker axes may exhibit characteristic errors as a function of axis position, both in static and dynamic measurement. Isolating them and evaluating them may indicate a significant error in a singular axis or in all axes. In the opposite extreme

case where the encoders are at the highest combination, the interaction may also increase error. By maximizing the interaction, the result may uncover a source of error.

3.4 Considerations for Test Procedures

For every procedure and setup, certain factors must be considered. The environment is always significant in measurement. The tracker calibration should also be monitored. Other considerations are the stability of the system, additional hardware used and human operation error.

3.4.1 Environment

With any measurement equipment, the environment can have a definite impact. The temperature of the environment surrounding the measurement object can impact the scales as well as the laser precision. The fortunate thing about this knowledge is that each of the tested trackers are equipped with a weather station to monitor the conditions. The weather stations are similar for all three, using small sensors on wires to be placed one near the tracker and one near the location where the measurement is being performed. The sensors are sensitive to temperature and humidity. The software is capable of making corrections for the environmental changes. The environmental conditions can also be manually input into the software when measuring.

When working with lasers, air quality must also be considered. In the following procedures, the tests used for comparison are performed under the same conditions at a close range in a lab used primarily for measurement purposes. In an industrial setting, consideration should be taken for the air quality.

3.4.2 Tracker Calibration

Like every measurement device, a tracker must be calibrated. The trackers are calibrated when they are manufactured or undergo maintenance; however they also come with calibration procedures built into the software. Before measurement procedures are performed it is important to evaluate the tracker. Compensation of the trackers using the individual processes with each setup provides a baseline for the capabilities of the tracker based on the standards specified by the company. The calibration sequence itself is a series of measurements used to determine any error between the measurement taken and a referenced value. The calibration values are displayed at the end of the sequence but the software also takes the values and compensates for them.

3.4.3 System Stability

When taking any remote measurement, the stability of the system is critical. If the tracker moves during a measurement sequence, the system will continue to measure but the movement will not be accounted for.. Vibration transmitted through the base will also have an effect on the measurement. Consideration should be taken to the surroundings of the testing area to limit any vibrations. A stable, locked base can prevent movement as well as an isolated area to avoid any collision or relocation from an outside source, most likely other people in the area

3.4.4 Software Settings

Software also offers a wide variety of options for not only processing but for the measurement function itself. Something to be aware of is ensuring that the settings are consistent throughout the measurement sequence. An example of this is collection

intervals in scanning. One option takes points in intervals based on how far the SMR travels while another option will collect based on the time elapsed.

3.4.5 Additional Hardware

Trackers have additional hardware kits available. Generally, the trackers have brand specific hardware but third party options are also available. Using different accessory kits, stands, and SMRs should be noted. The uncertainty in the measurement should account for all certified equipment. Nests, SMRs and other accessories are generally sold with an uncertainty value recorded and associated with it.

3.4.5 Human Error

The biggest source of error in most systems is human error. With a frameless system, like the tracker, the operator is the link between the tracker and the target. The measurements are dependent on the capability of the operator. In designing a standardized method, it should be laid out so that someone with basic training on the system can carry them out or specified so that a trained professional is required to complete them. Repeating the process can help identify inconsistency in the process as well.

CHAPTER 4: SURFACE PLATE EVALUATION

4.1 Introduction

The first evaluation method used was a Union Jack scan of a surface plate using a precision straight edge. Our goal for this method is to determine the measurement deviations from a known surface. Using a surface plate gives us a surface that is close to “known” from the certification of the manufacturer. The scan was designed based on current surface plate evaluation standards. The test used precision equipment and was performed manually at varying speeds. The distinct speeds allowed for an initial look at the effects of target speed on the measurement.

4.2 Equipment

The test was performed using the rated granite surface plate and straight edge. The uniform thermal coefficient is ideal for the non-temperature controlled setting, although temperature gradients surrounding the surface should be considered. Surface plates were certified and graded when manufactured and cleaned thoroughly prior to any measurements. One of the surface plates used, as well as the straight edge, are shown in Figure 7.

4.3 Setup

For this test, all three trackers were networked and located in a direct line of sight of the surface plate. The surface plates were placed on a stable table and cleaned with

appropriate cleaner. The setup of the surface plate and an example of the tracker setup are shown in Figure 7 and Figure 8.



Figure 7: Surface plate and straight edge used

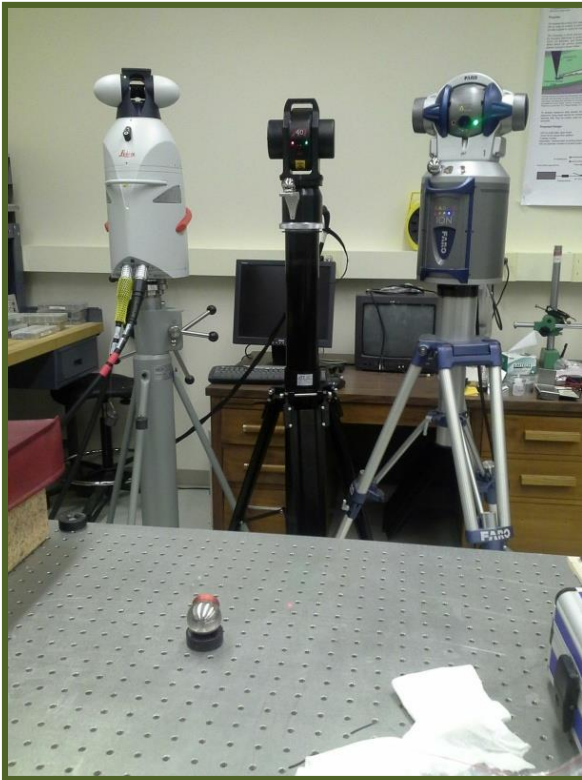

Figure 8: Networked tracker setup

4.4 Procedure

Once the trackers are placed and running, all calibration procedures were run and recorded. After calibration the trackers were located by measuring six reference points mounted on surfaces around the room. Using the six points in Spatial Analyzer, the trackers were located and tied to a single coordinate system. The transformation allows for a unified view in the software but was not considered when analyzing the data.

Once located, the trackers are aimed at a single 1.5 inch SMR. The SMR is dragged along the surface of the plate in a “Union Jack” pattern replicating the one used in ASME B89.3.7-2013, the standard used to evaluate surface plates for grading.

Figure 9 shows the pattern used and the Figure 10 refers to the pattern from the standard.

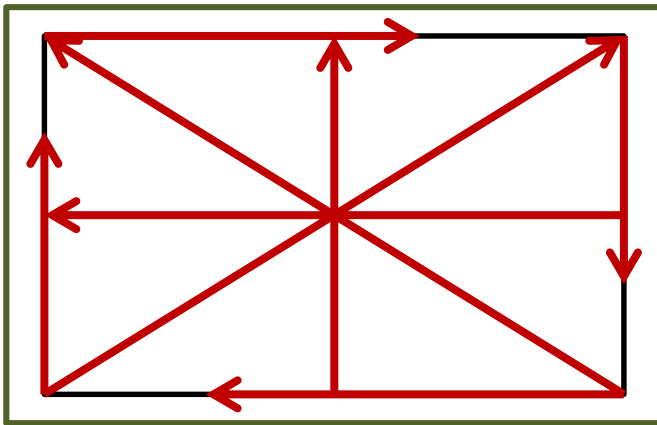

Figure 9: Union Jack pattern used in scan

Fig. I-4 Eight-line Calibration Pattern for Rectangular and Round Surface Plates

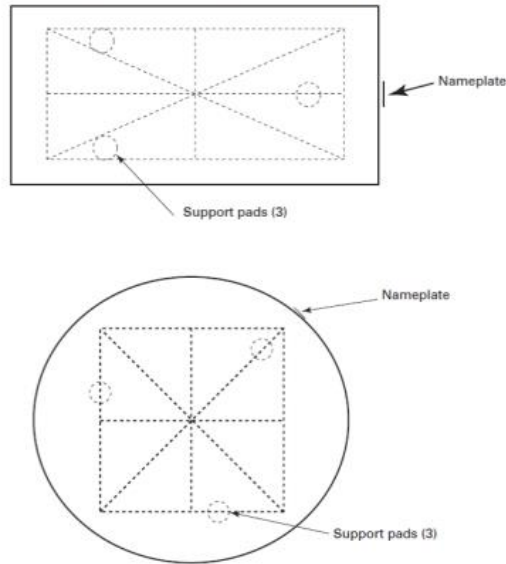

Figure 10: Surface plate evaluation pattern from ASME B89.3.7-2013

Each scan was done at two distinct speeds. Because the scan was performed by hand, the speeds were not controlled. The slow scan was around 25 mm/s and the faster scan was around 150 mm/s. Originally, the scan was performed using edge nests and flat nests but the nests eliminated small variations on the surface so the SMR was used in direct contact with the surface plate.

4.5 Data and Analysis

Scan data were collected in SA and processed. For each scan, the data is automatically assigned a coordinate system at the head of the tracker. Using lines established by the scan, the datum system was transformed to the fitting plane of the data for comparison. Using the software, the surface scan was laid out and a range of values, referenced to the surface plane were found.

In some cases, certain sections of the scan returned significant variations. After investigation, it was attributed to damage on the surface plate. In these cases, the section was disregarded in the range values reported below. An example of the analysis in the

software is shown in Figure 11. The damaged area is visible in the upper left hand part of the image.

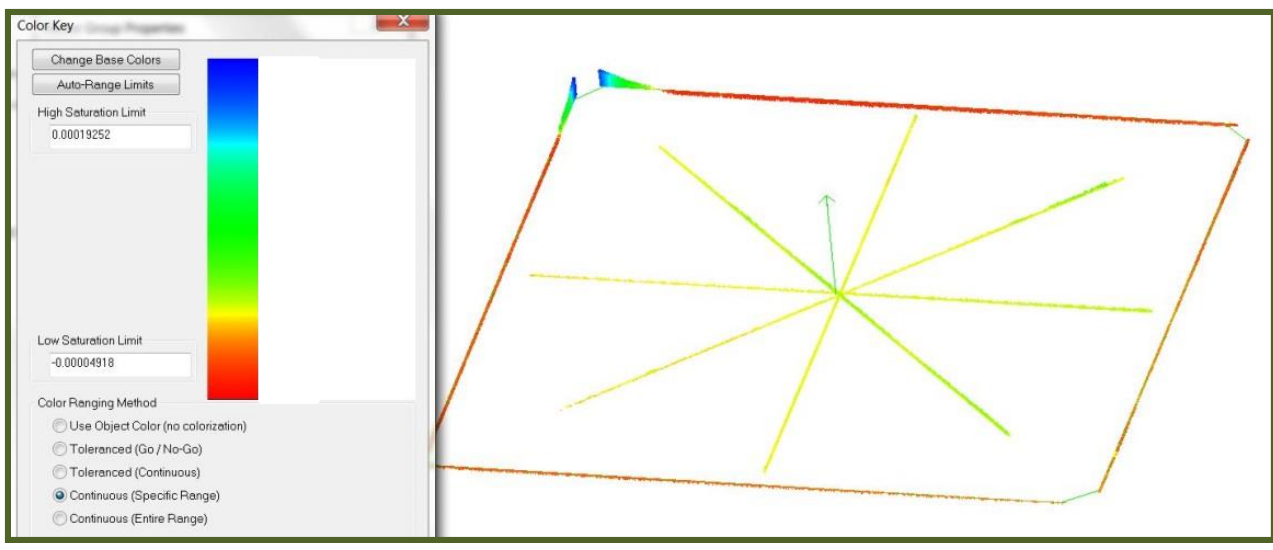

Figure 11: Example of analysis interface of surface plate

The variation in the ranges from tracker to tracker as well as from “fast” scan speed to “slow” scan speed were compared. Table 1 shows the range values from one scan set.

Table 1: Data ranges for a scan after discarding damaged area

	Tracker 1	Tracker 2	Tracker 3
“Fast” Scan range	-57 μm to 330 μm (387 μm)	-36 μm to 38 μm (74 μm)	-20 μm to 20 μm (40 μm)
“Slow” Scan range	-49 μm to 193 μm (242 μm)	-42 μm to 26 μm (68 μm)	-20 μm to 20 μm (40 μm)

The ranges for the scans performed at “fast” speed show a larger range of values in two cases than those done at “slow” speed. There were also consistently variations in range sizes from tracker to tracker.

Because the surface plate scan was done manually, the ranges may be significant but aren't conclusive. Further investigation into the effects of target speed is done in the following experiments.

CHAPTER 5: ROTATING BALL BAR EVALUATION

5.1 Introduction

After determining the results of manual linear scanning, the next tests were of circular scans. These scans will allow the testing of varying axis interactions, as well as having a controlled motion not subject to manual variations.

The rotating ball bar setup was designed to vary the speed of the SMR in a regular, measurable way. By using an air bearing spindle, the error due to vibration and friction is limited. Using a rotating bar driven by a simple motor, we were able to consider rotational velocity as a variable. Matt Bellassai, an undergraduate research assistant, assisted in the design and manufacture of the test equipment for this evaluation method.

5.2 Equipment

The rotating ball bar setup includes the following:

- PI Block-Head Air bearing
- Carbon fiber magnetic bar ball
- Servo motor
- LabVIEW control system

All equipment was chosen with consideration to limiting outside variables. The entire system was mounted on a heavy base to dampen any vibration from the floor. The Block-Head spindle is specified by Professional Instruments to perform radially and

axially to under $1\ \mu\text{m}$. The carbon fiber bars minimize both thermal expansion and the force effects of rotation and weight of the SMR, allowing for the assumption that the radius of rotation is accurate to under $50\ \mu\text{m}$.

5.2.1 Rotating Ball Bar Setup

The components detailed above were mounted as shown in Figure 12. The spindle was mounted in an angle plate attached to a base by a three point mount and seated on an aluminum base, secured to a heavy steel stand. The ball bar is attached to the spindle using an attachment with a v-groove and a rubber insert with low elasticity.

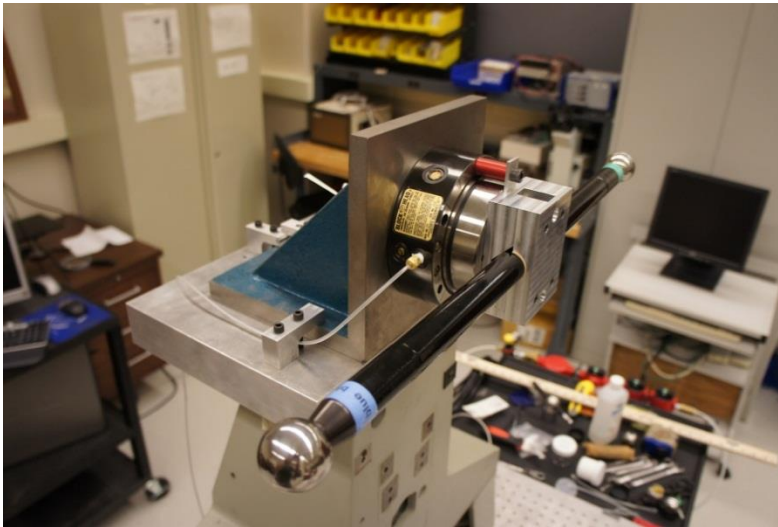

Figure 12: Setup of rotating ball bar using an air-bearing spindle

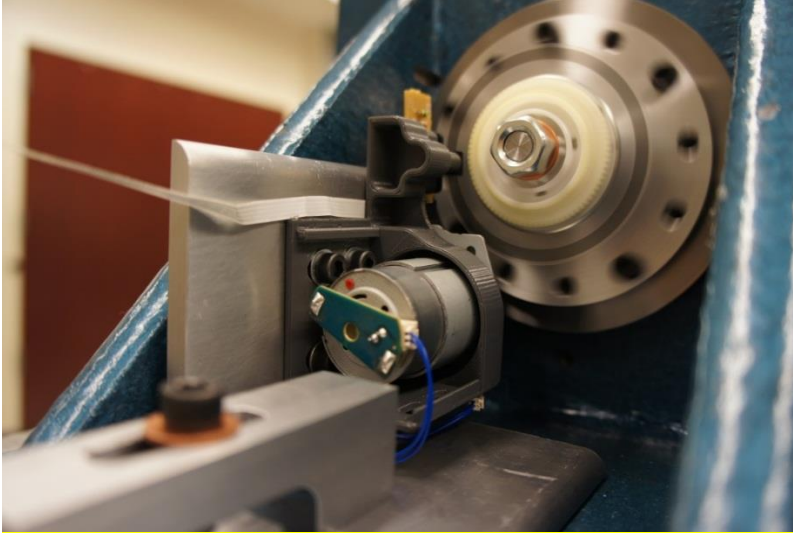

Figure 13: View of motor and encoder setup for spindle operation

5.2.2 Labview Interface

The spindle was run through a LabVIEW program. The program allows for programmable rotational speed changes. The program addresses voltage discrepancies and corrects as much electrical noise as possible. The output velocity is shown, so the input voltage is varied until the desired output is reached and stable. The rotation can also be changed to run scans clockwise or counter-clockwise. Figure 14 is a screenshot of the control panel for the setup. By entering the desired rotational speed, the program determines the required voltage. The actual rotational speed is shown so the voltage can be manually manipulated to return the desired speed. The control panel also allows for directional change as well as the ability to save the output and speed information.

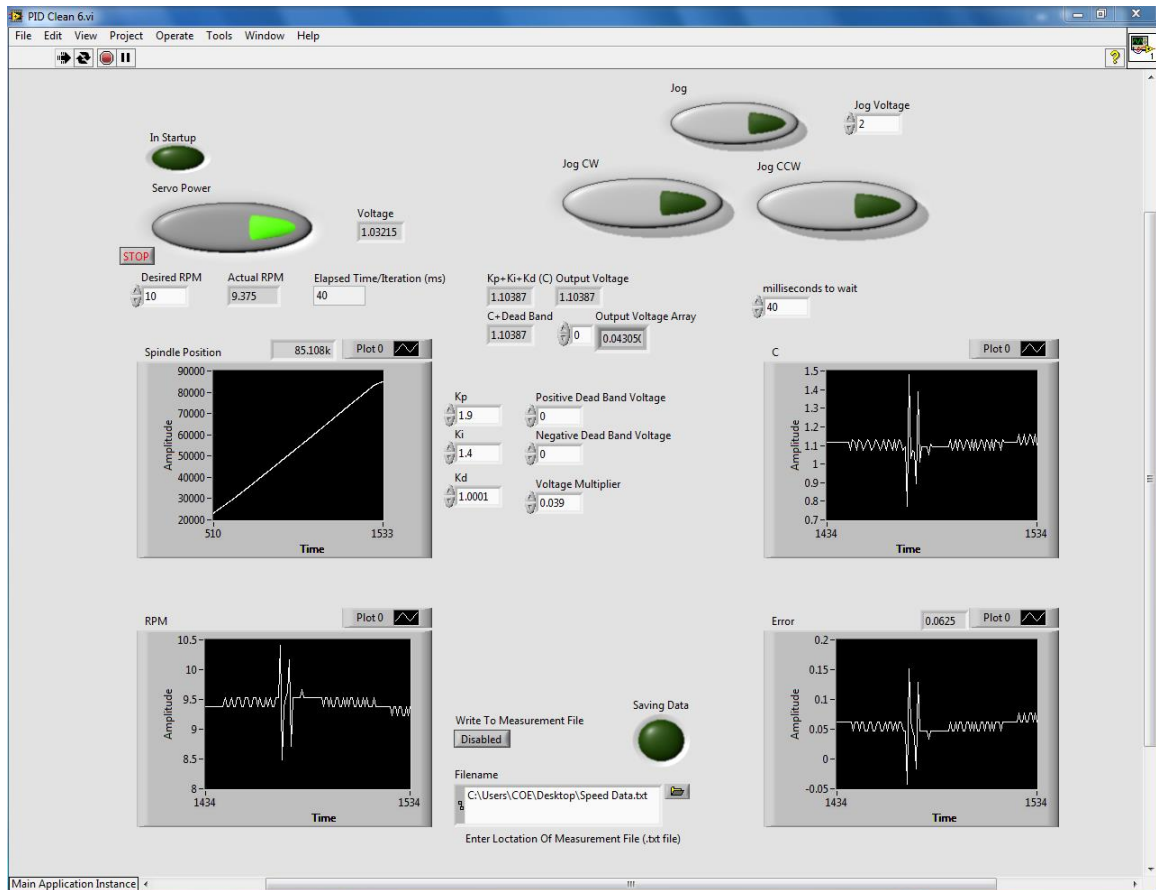

Figure 14: Labview control panel

5.3 Setup

For this test setup, the trackers were used individually. Each of the trackers was aligned and tested in the same controlled environment but not simultaneously. Any temperature variation was addressed by the weather station integrated into each tracker. Ventilation, a major cause of pressure changes, was also limited during scans by avoiding measurement while the air conditioning was cycling.

The trackers were placed at a designated distance from the spindle. The locations were designated at 1, 2 and 4 meters from the setup. The tracker is preliminarily placed on a mark and location measurements are taken. The coordinates are taken and adjustments are made to align the rotational axes of the tracker and the bearing using a

coordinate system built at the rotational center of the ball bar and aligning the axis of the tracker head to it.

5.4 Procedure

Once the tracker is calibrated and properly aligned, a 1.5 inch SMR was mounted in a nest at the center of the ball bar and scanned to properly align the tracker to the center of the spindle. Identical 1.5 inch SMRs are mounted at either end of the ball bar. The bar is rotated at increasing velocities of 5, 10, 25, 50, and 100 rpm. The direction of the spindle was reversed and the measurement retaken. The tracker was moved to the next position and scanned again.

5.5 Data and Analysis

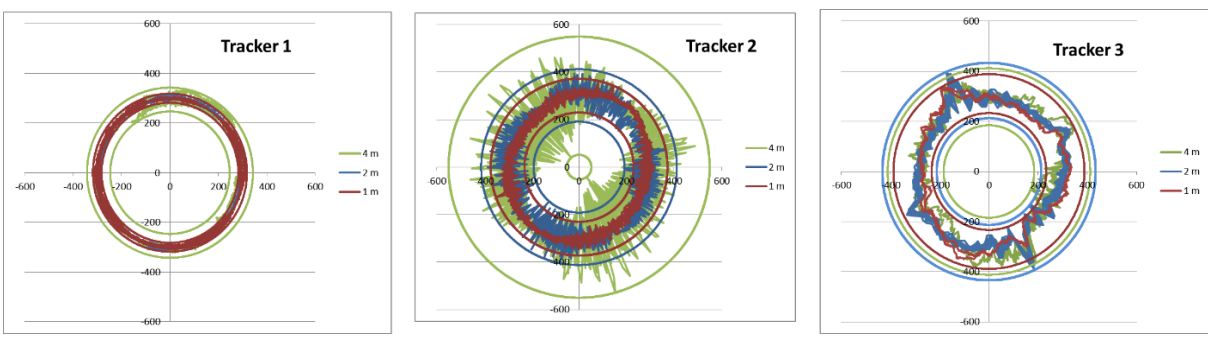

Figure 15: Circular representation of the data at varying distances

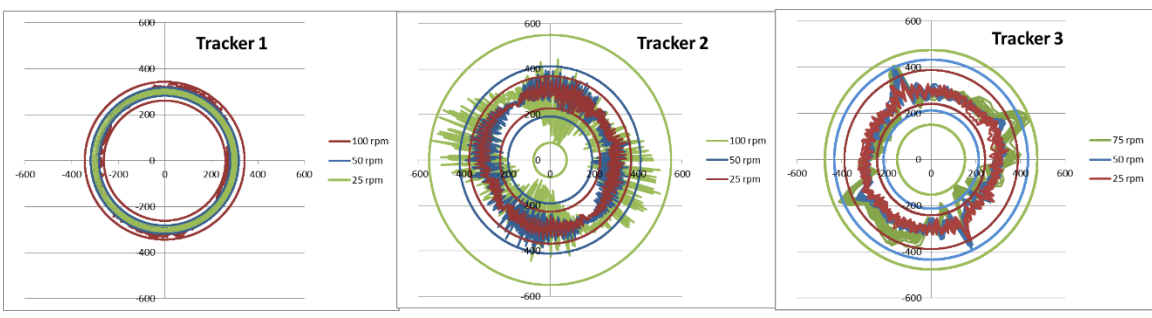

Figure 16: Circular representation of the data at varying speeds

The data sets were converted to a central coordinate system in SA for analysis. The error ranges were found and compared using Excel, based on a circle best fit to the data. Figure 15 and Figure 15 show the data mapped in a circle with the range of each highlighted with encompassing circles at the maximum and minimum radii.

The patterns of the distance change and the rotational speed change were the two variables of focus, so they were broken down to determine a trend. Figure 17 and Figure 18 the data from each tracker at each location are compared.

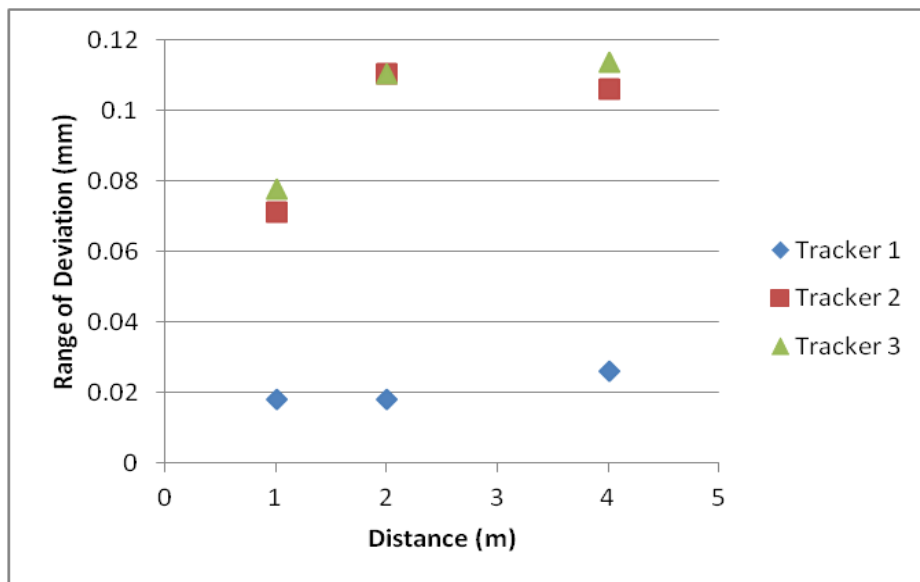

Figure 17: Deviation range by distance to measuring object

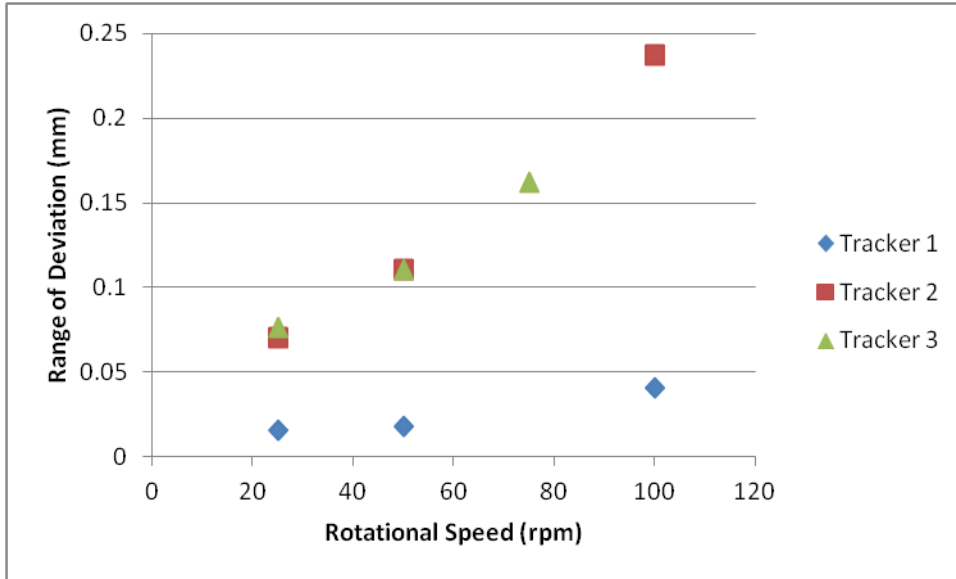

Figure 18: Deviation range by rotational speed

There is no trend seen based on the distance to the measuring object. The values from the evaluation are below in Table 2.

Table 2: Values for comparison based on distance from measuring object

Distance (m)		2	2	2	4	4	4
Radial Velocity	RPM	5	50	100	5	50	100
	Rad/sec	0.52	5.24	10.47	0.52	5.24	10.47
Radius of Rotation (mm)		7.41	7.41	7.41	3.75	3.75	3.75
Tangential Velocity (mm/sec)		3.88	38.79	77.58	1.96	19.64	39.28
Error Range (μm)		28.58	18.14	40.44	57.47	49.32	65.18
	<i>Min</i>	-11.09	-8.88	-18.69	-28.53	-26.86	-30.98
	<i>Max</i>	17.49	9.26	21.75	28.94	22.45	34.19

The trend inferred by Figure 18 suggests that the rotational speed corresponds directly with the deviation. The same trend in rotational velocity variation was seen in all three trackers. A trend can be inferred in the distance, but not consistently in all three trackers. The data sets were further compared by angular encoder velocity to further observe the pattern. Table 3 gives values for the three trackers at similar encoder velocity. The encoder velocity relates to the motion in the tracker head.

Table 3: Error range and RMS values at various angular acceleration

Distance/Speed	Ang. Encoder	Ang. Encoder	Range			RMS		
	Velocity (Rad/sec)	Acceleration (Rad/sec ²)	(mm) Tracker 1	(mm) Tracker 2	(mm) Tracker 3	Tracker 1	Tracker 2	Tracker 3
1m, 25 rpm	0.784	2.054	0.016	0.057	0.048	0.003	0.008	0.006
2m, 50 rpm	0.783	4.099	0.018	0.110	0.110	0.003	0.016	0.014
4m, 100 rpm	0.783	8.199	0.059	0.279		0.011	0.049	

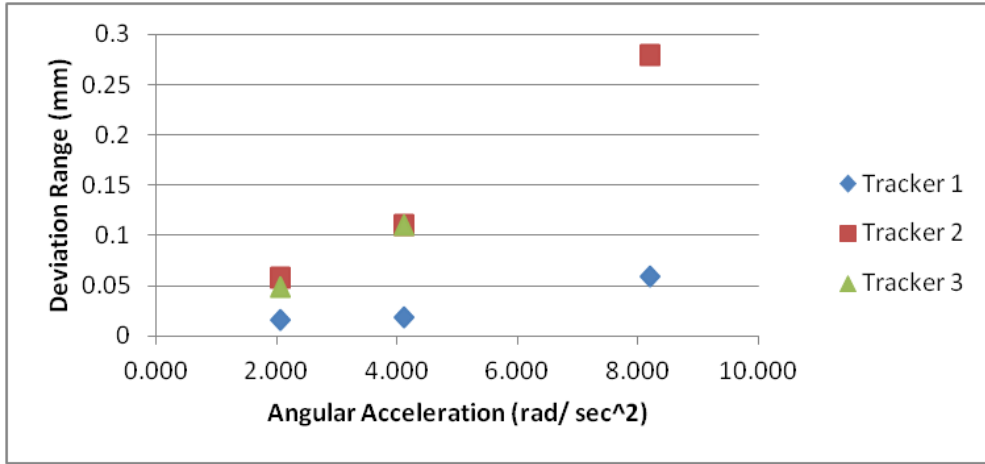

Figure 19: Deviation when Angular Acceleration is varied

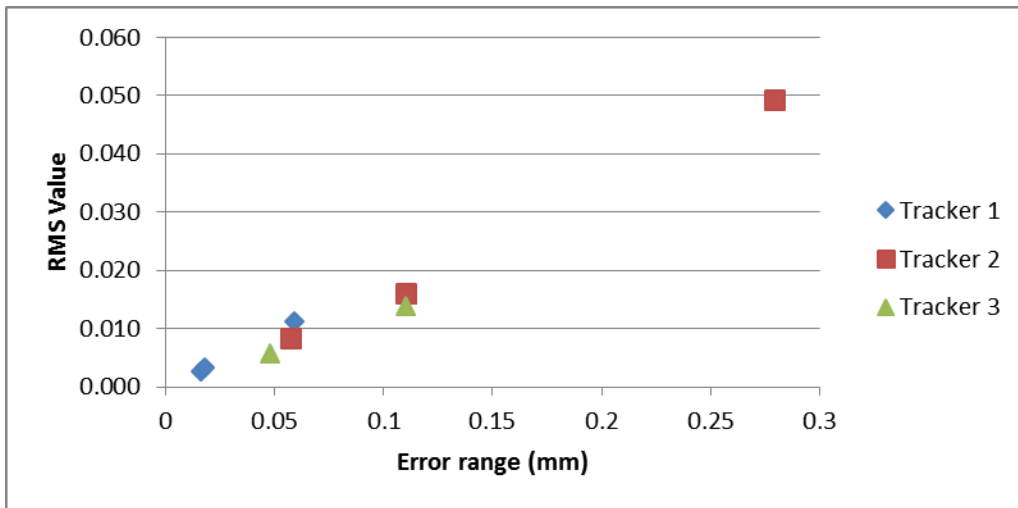

Figure 20: Relationship between the RMS and error range for the trackers

Figure 20 demonstrate that the RMS and the error ranges have a direct relationship. The relationship indicates that the errors are distributed over the range and are not just outliers. These similarities prove that this is an applicable test for all three trackers.

Other patterns were seen in Figure 15 and Figure 16 show a trend toward polar error where the ranges are largest at apexes around the circle. The next test, addressing isolated axes with a linear scan, explores the axes and interactions as distinct variables.

CHAPTER 6: PRECISION SLIDE EXPERIMENT

6.1 Introductio

Based on the previously detailed evaluations, a linear slide evaluation was chosen as the next step. Using a precision driven linear slide and orienting the tracker at different locations with respect to the target, the axes of the tracker could be isolated for comparison. One setup is also designed to combine two axes to look for a maximum error in situations when the encoders are directly interacting.

6.2 Equipment

The precision slide setup includes the following:

- Linear Slide
- Computer with NView and NScope programs

All equipment was chosen with consideration to limiting outside variables. The slide is calibrated to within +/- 5 μm and the setup is mounted on a vibration controlled laboratory table.

6.2.1 Precision Slide

The slide is an air-bearing track, high precision slide. The position control is run through a PC with programmable motion sequences and a viewing panel to monitor the motion of the slide. Some of the characteristics that can be mapped in the software are shown in Figure 22 below.



Figure 21: Precision slide setup

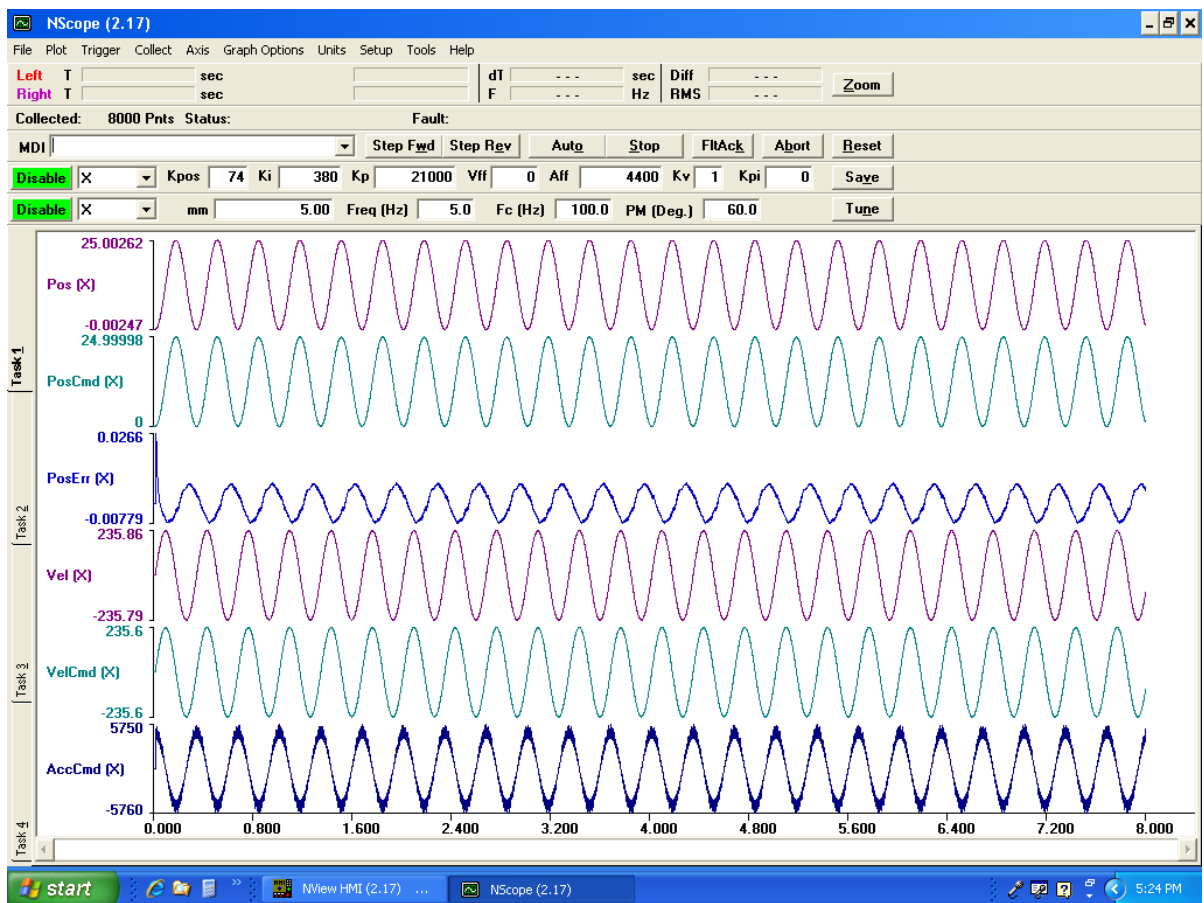

Figure 22: NScope readout screen view

6.3 Tracker Orientations

The tracker is aligned to the slide in two positions to isolate the azimuth and the elevation from each other. A third setup is used to maximize the interaction between the encoders of the azimuth and elevation. The fourth configuration is a setup using a mirror to isolate the ranging measurement. The four orientations provide a comparison between the axes to find exactly where the uncertainty in the tracking function is maximized.

6.3.1 Azimuth Isolation

To isolate the azimuth, the tracker is placed perpendicular to the direction of travel at the target home position. Figure 23 below shows what this setup would look like.

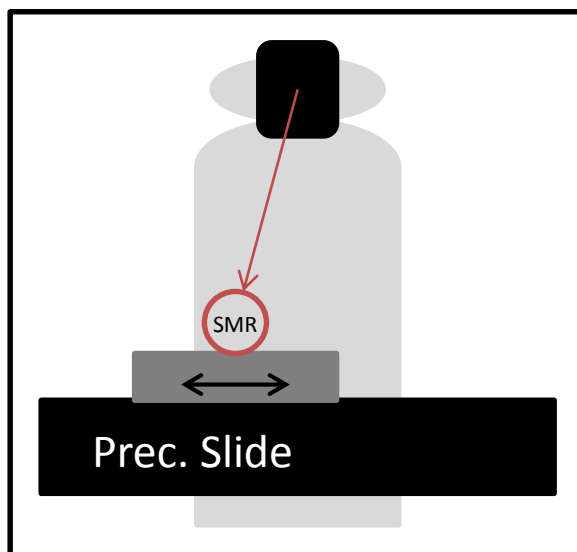

Figure 23: Slide set up to isolate azimuth

6.3.2 Elevation Isolation

To isolate the elevation, the tracker is aligned to the center of the direction of travel. The tracker should be placed as close as possible to the home position of the target to maximize the change in angle made by the tracker head. The setup is shown below in Figure 24 A mirror is shown for circumstances when the target cannot be seen.

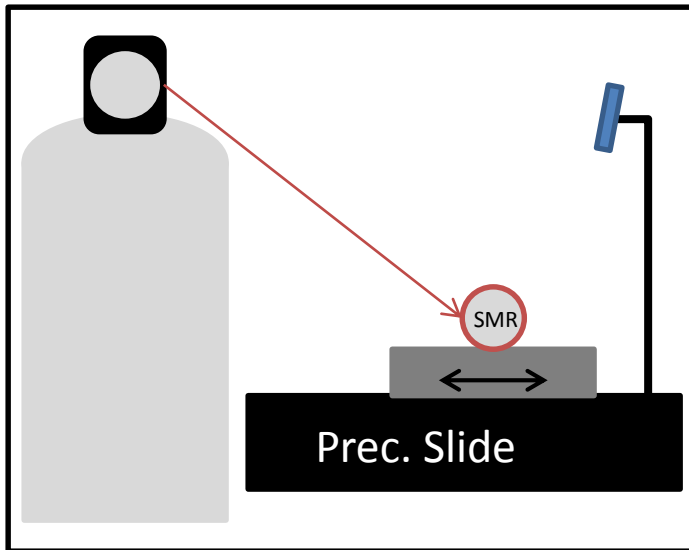

Figure 24: Setup for elevation isolation

6.3.3 Encoder Combination

The third configuration is a position to evaluate the interaction of the encoders in the two rotary axes of the tracker. Aligning the tracker to a 45 degree corner angle corresponding to the center position of the range of motion. This position allows us to look for an arc in the data as the angles are changing at the same rate. Figure 25 and Figure 26 below show what the setup would look like.

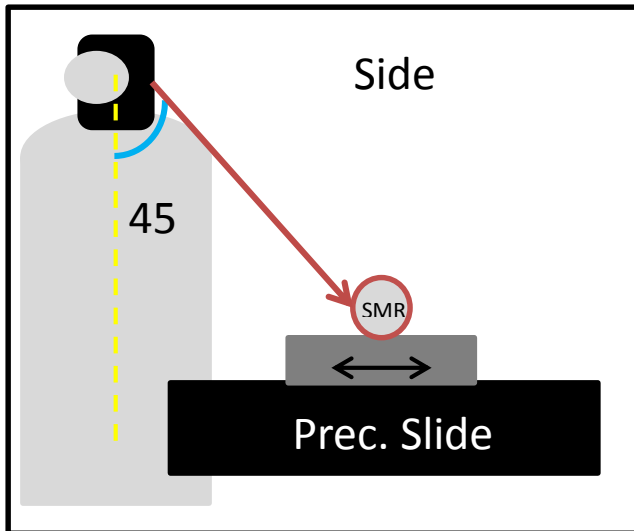

Figure 25: Side view of 45 degree axis combination

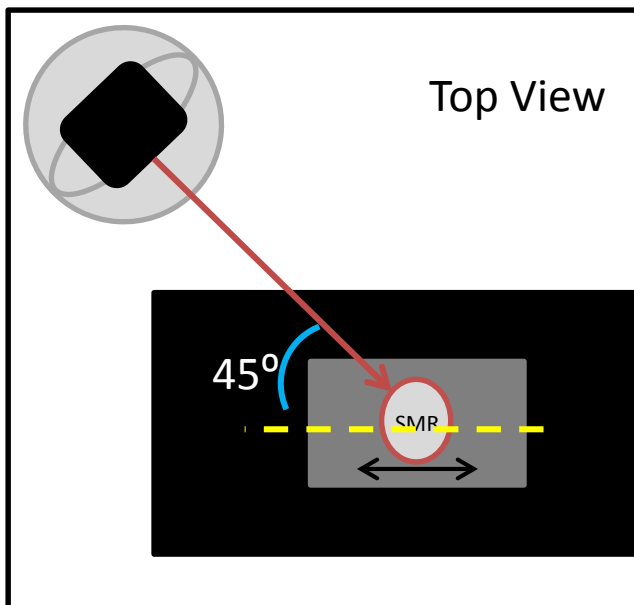

Figure 26: Top view of 45 degree axis

6.3.4 Ranging Isolation

The ranging component in the tracker is either absolute distance mode or interferometry mode. Isolating the ranging axis is expected to demonstrate the lowest errors. When testing the ranging capability, both modes, IFM and ADM, should be considered. Because laser ranging is providing a constant read out when the beam is

unbroken, the distance should be accurate throughout the movement. The ranging axis is certified upon manufacture and the standard covers a static evaluation of the range.

Interferometry and absolute distance measurements are used in many other methods of measurement and have demonstrated a high level of accuracy. The majority of the errors in measurement are assumed to come from the rotary axes of the system. To isolate the ranging axis, a mirror is used as shown in Figure 27: Ranging axis isolation setup.

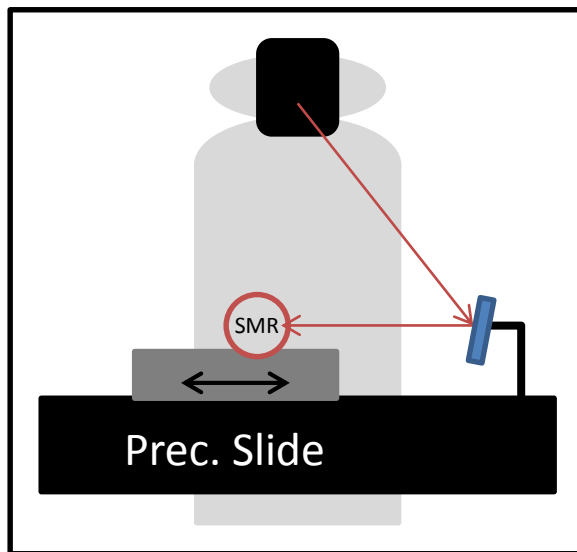

Figure 27: Ranging axis isolation setup

6.4 Procedure

The tracker is placed in each position and the slide is oscillated 20 mm between eight and ten times. The data is tracked by both the slide and the tracker.

6.5 Data and Analysis

6.5.1 Synchronization

The data from the tracker is directly compared with the data recorded by the slide software using an ideal sinusoidal wave established from the positional data of the slide.

The data is fit and the error range is observed. The graphical representation of the fitting process is shown below.

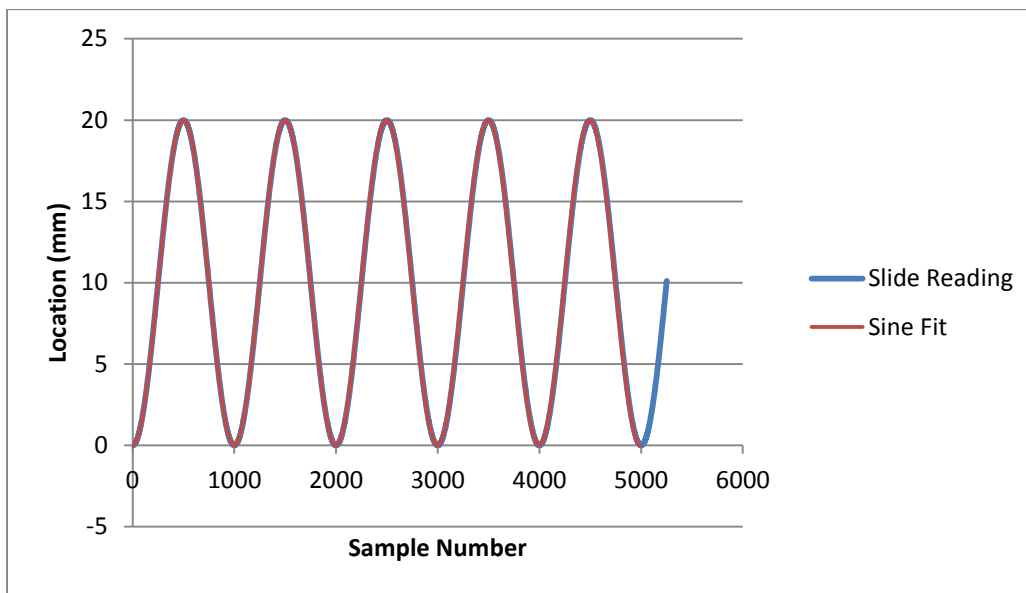

Figure 28: Sine fit to slide reading

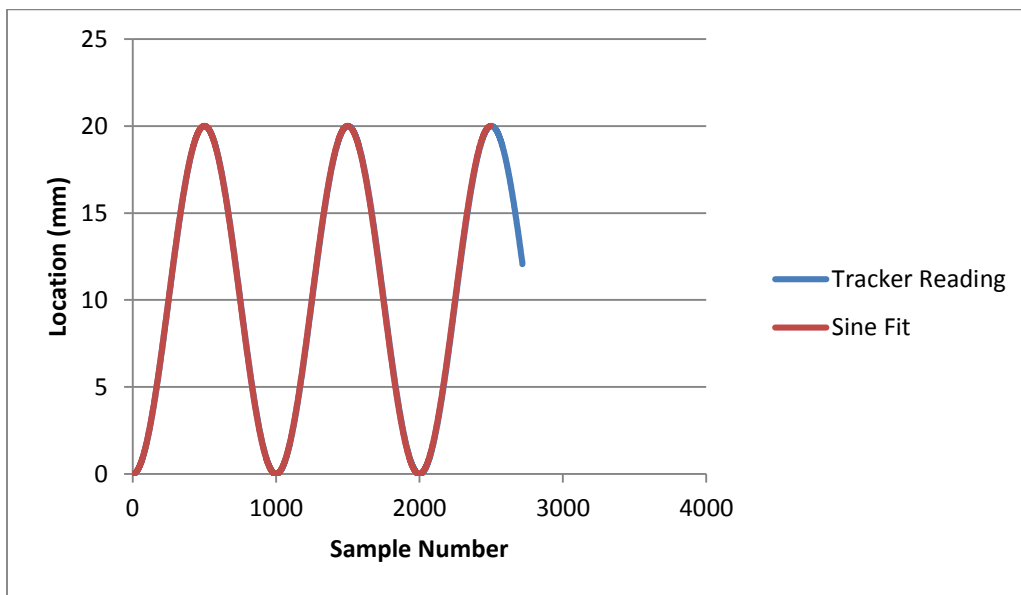

Figure 29: Sine fit to tracker reading

When isolating the tracker axis in this test, the slide provides data that allows us to see how closely the tracker can collect data in relation to time. For some applications, the ability to track location in time is an important attribute. Looking at the slide data in comparison to the trackers position data we can see how closely it can follow the target. Fitting the results can be difficult because the data collection is not perfectly synchronized in the two independent systems. It is also obvious in some cases that the data may lag or drop out over the range, resulting in large jumps in the data. This is important to note when using the system for a time-based evaluation.

Distance

The distance axis was isolated using a mirror in a direct line with the moving SMR. With the tools available, only one tracker could maintain connection with the SMR in motion. The results are shown below in Figure 30 and Table 4. The values observed are so small that they are within the certification for the system based on the manufacture's claims. For this system, they appear almost negligible. Though this is encouraging, investigation is still necessary based on lack of comparison to other trackers.

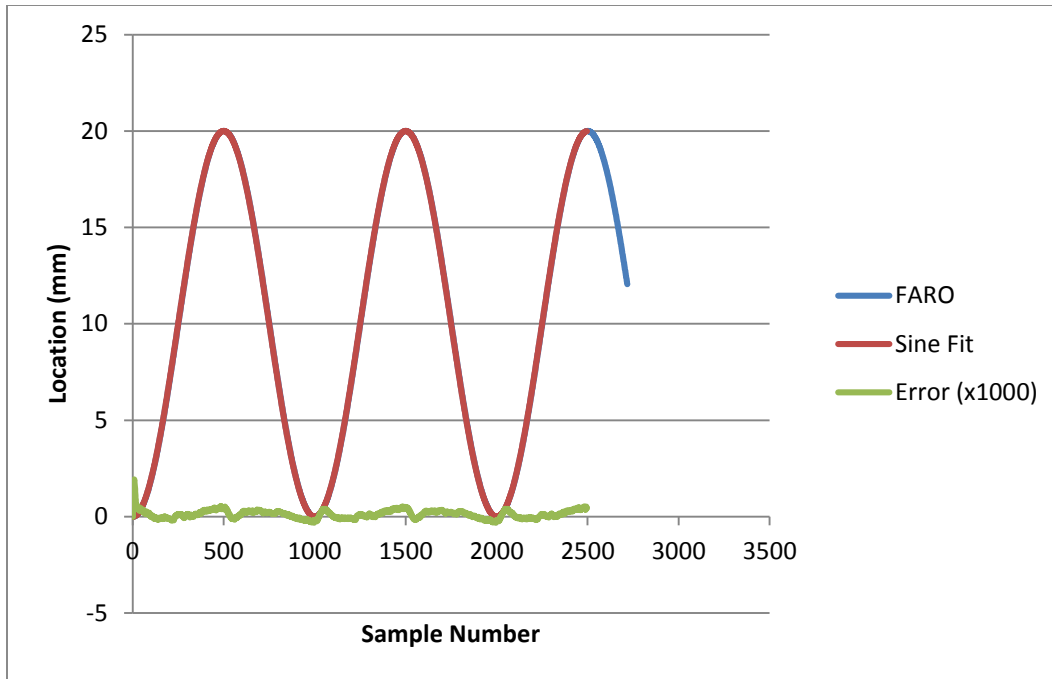

Figure 30: Sine fit of the distance isolation of the FARO tracker with errors graphed

Table 4: Error Values for distance measurement

	Distance (μm)
RMS	0.011910434
Max	-0.261535515
Min	-0.271030655
Range	0.00949514

Azimuth and Elevation

The azimuth and elevation were isolated and mapped each of the trackers. In the figures and tables below, the results are shown. The values in the table are based on a single cycle that demonstrates the best portion of the sine fit.

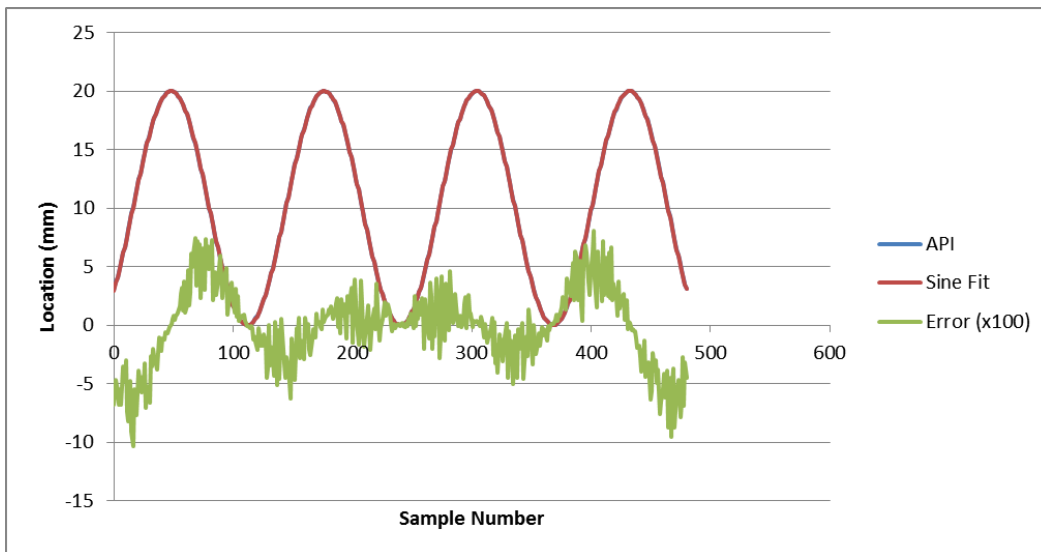

Figure 31: Sine fit and error of API elevation measurement

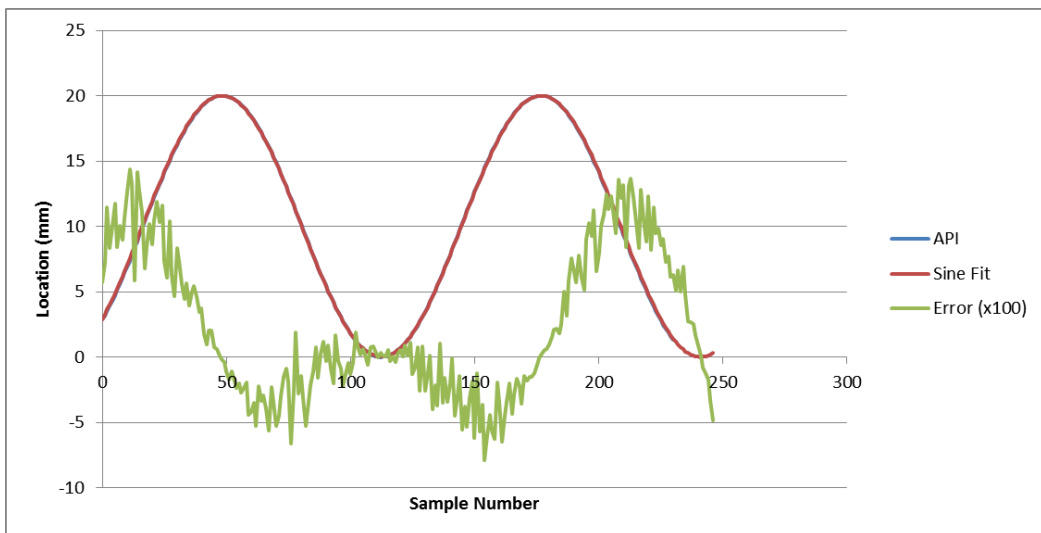

Figure 32: API azimuth sine fit and error

Table 5: RMS and error range for API analysis

	Azimuth	Elevation
RMS Error	1.054991 μm	0.189893 μm
Error Range	5.318376 μm	2.1131 μm

Looking at the error values for the API, the RMS values are both within 5 micron even though the azimuth value is higher. The ranges demonstrate that there may be some lag, based mostly on the elevation maximum being much higher than the RMS value.

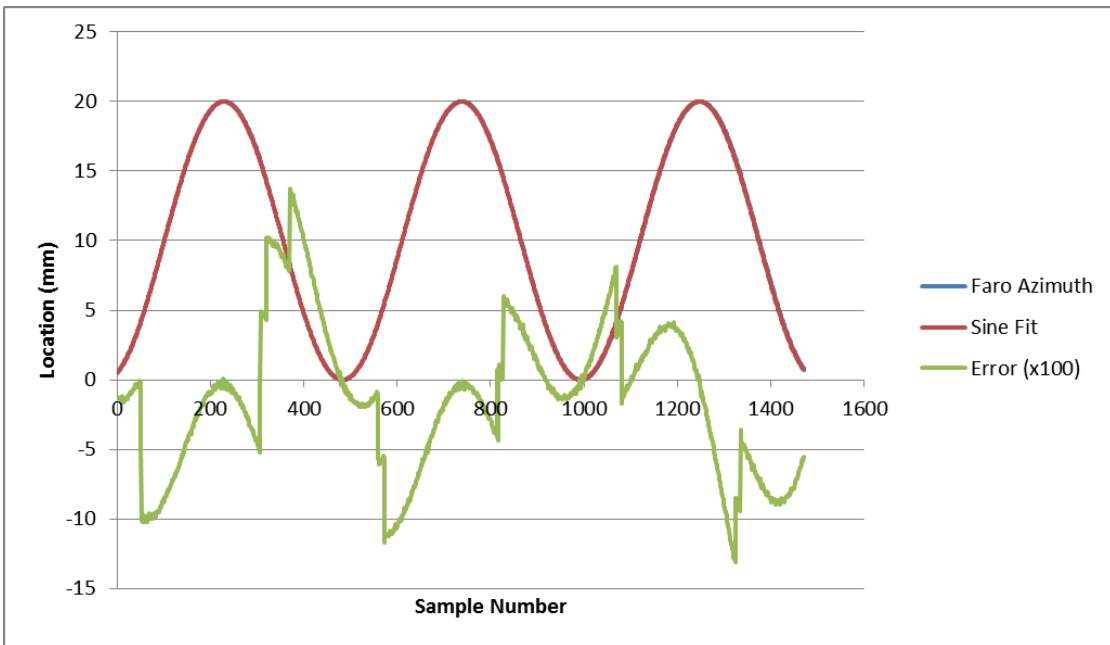

Figure 33: Sine fit and error for Faro azimuth measurement

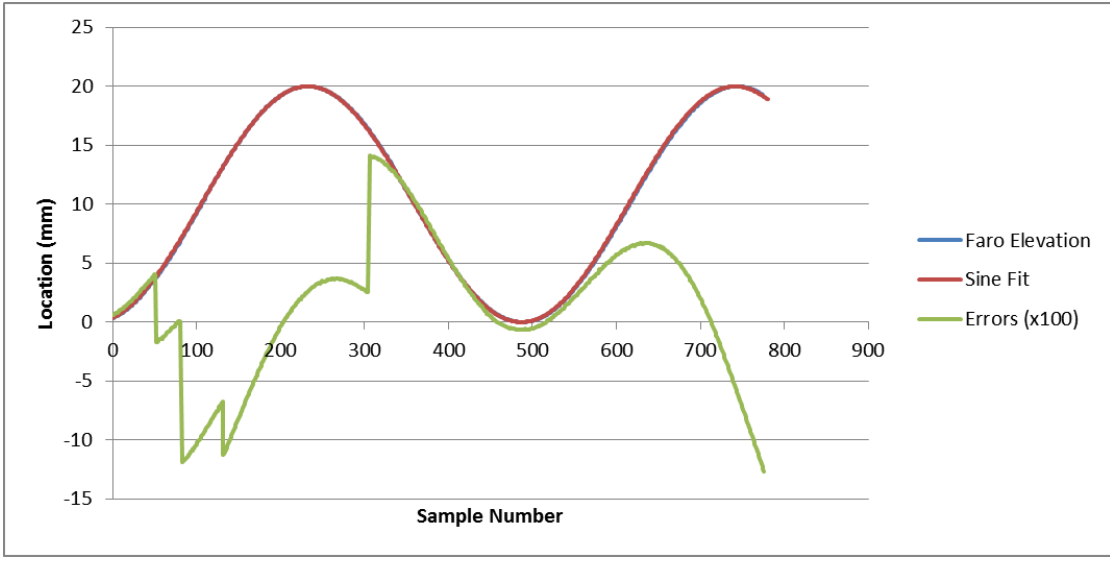

Figure 34: Sine fit and error for Faro elevation measurement

Table 6: Error values for Faro evaluation

	Azimuth	Elevation
RMS	0.45 μm	0.64 μm
Range	1.76 μm	2.60 μm

The FARO RMS values are also low over the range but both graphs shows spikes and high ranges indicating lag in the data.

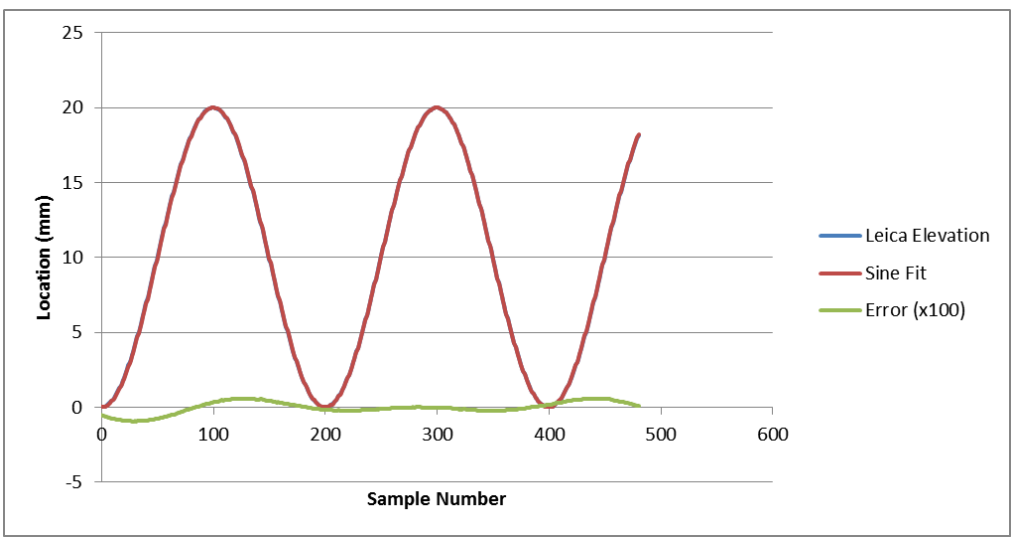

Figure 35: Leica elevation fit and error

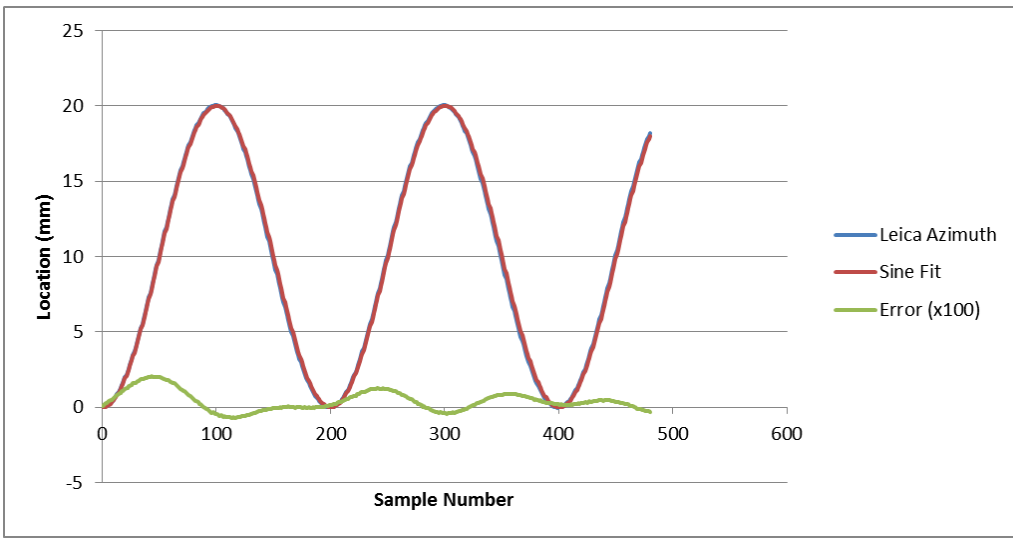

Figure 36: Leica azimuth fit and error

Table 7: Error values for Leica Evaluation

	Azimuth	Elevation
RMS	2.201132 μm	0.15 μm
Range	1.680386 μm	0.30 μm

The Leica results do not demonstrate any large drop outs but show a noticeable difference between the two axes. Looking at the design of the tracker, the azimuth is rotating a much larger mass than the elevation so this result may indicate errors induced by the design.

Combination

After the axes were isolated, another setup was tested to maximize the interaction between the encoders. The figures and table below convey the results.

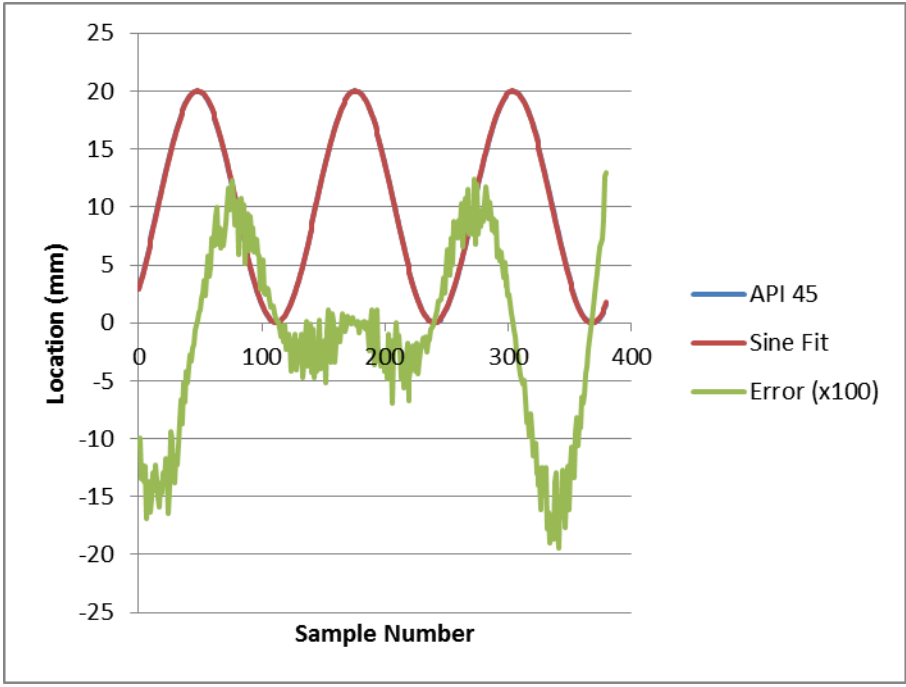

Figure 37: API data for 45 degree evaluation

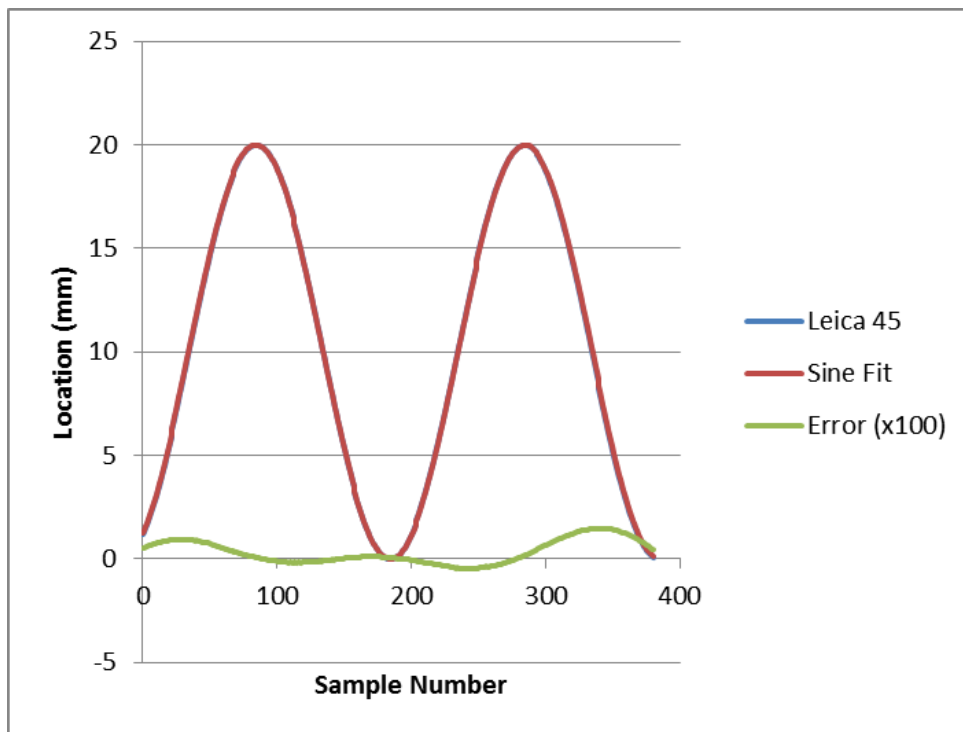

Figure 38: Leica data for 45 degree evaluation

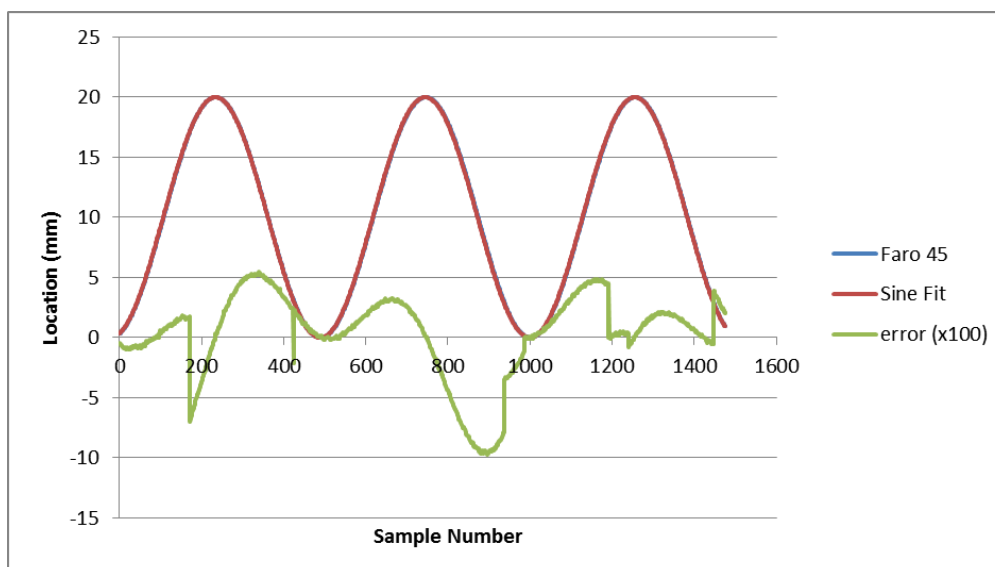

Figure 39: Faro data for 45 degree evaluation

Table 8: Error values for 45 degree evaluation

	API	FARO	LEICA
RMS	0.381 μm	0.296 μm	0.124 μm
Min	-0.697 μm	-0.699 μm	-0.294 μm
Max	1.074 μm	0.549 μm	0.120 μm
Range	1.770 μm	1.248 μm	0.413 μm

The combined angles do not show a consistently higher or lower value than the individual axes but indicate a similar result. The RMS values are not noticeably higher or lower for the combined angle, indicating that the time-based tracking capability may not be influenced by combining the encoder axes. Something else to consider is a possibility of controller being improperly tuned

6.5.2 Geometric Deviation

Another aspect we can investigate using the slide data is the deviation from the position in space. By fitting the data to the slide axis, we can determine from the remaining axes the deviation from that line. The slide operates with minimal deviation as certified by the manufacturer. By isolating the deviations from each axial measurement, we can observe the positional accuracy of the tracker.

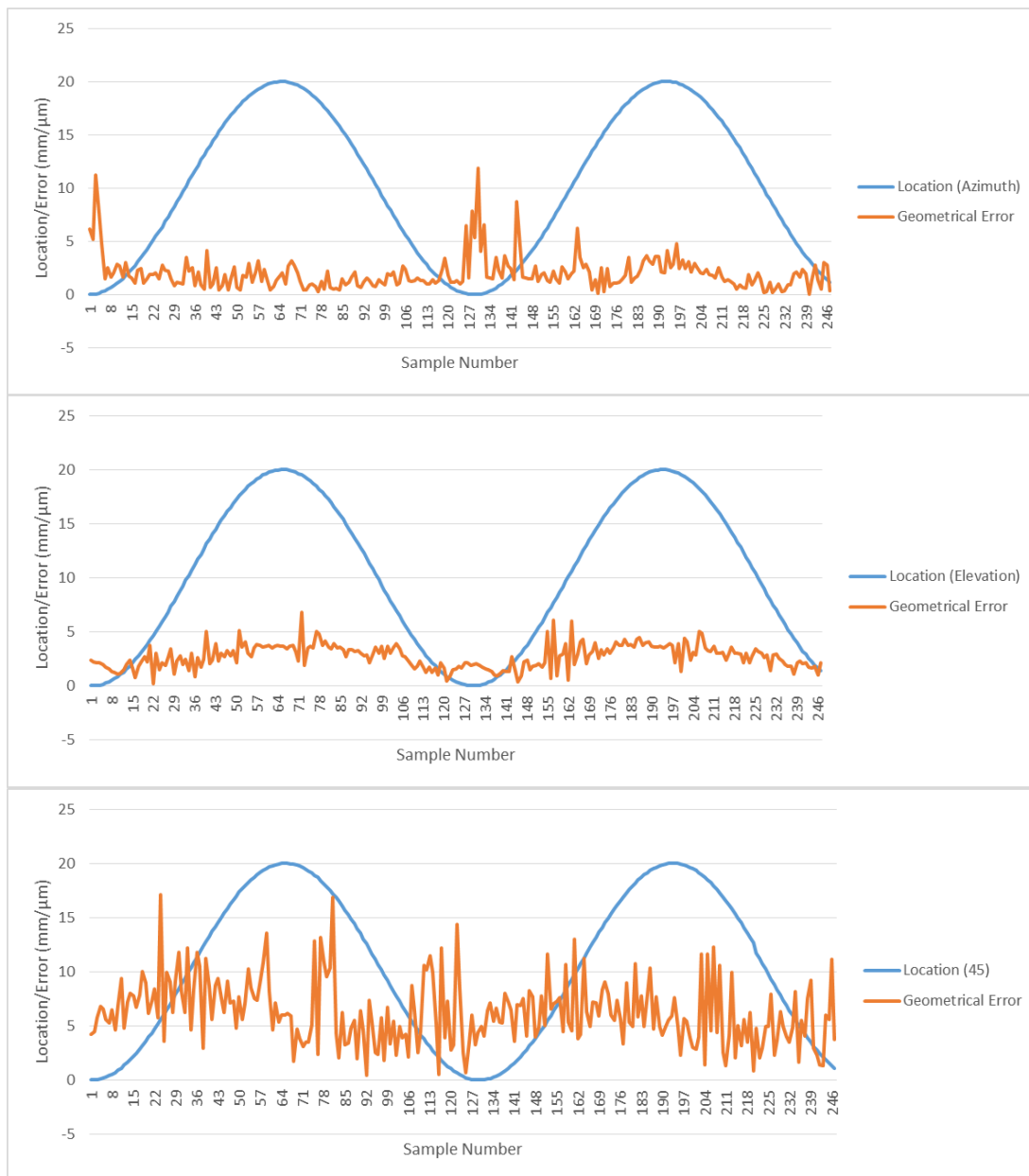

Figure 40: Deviation results for API tracker

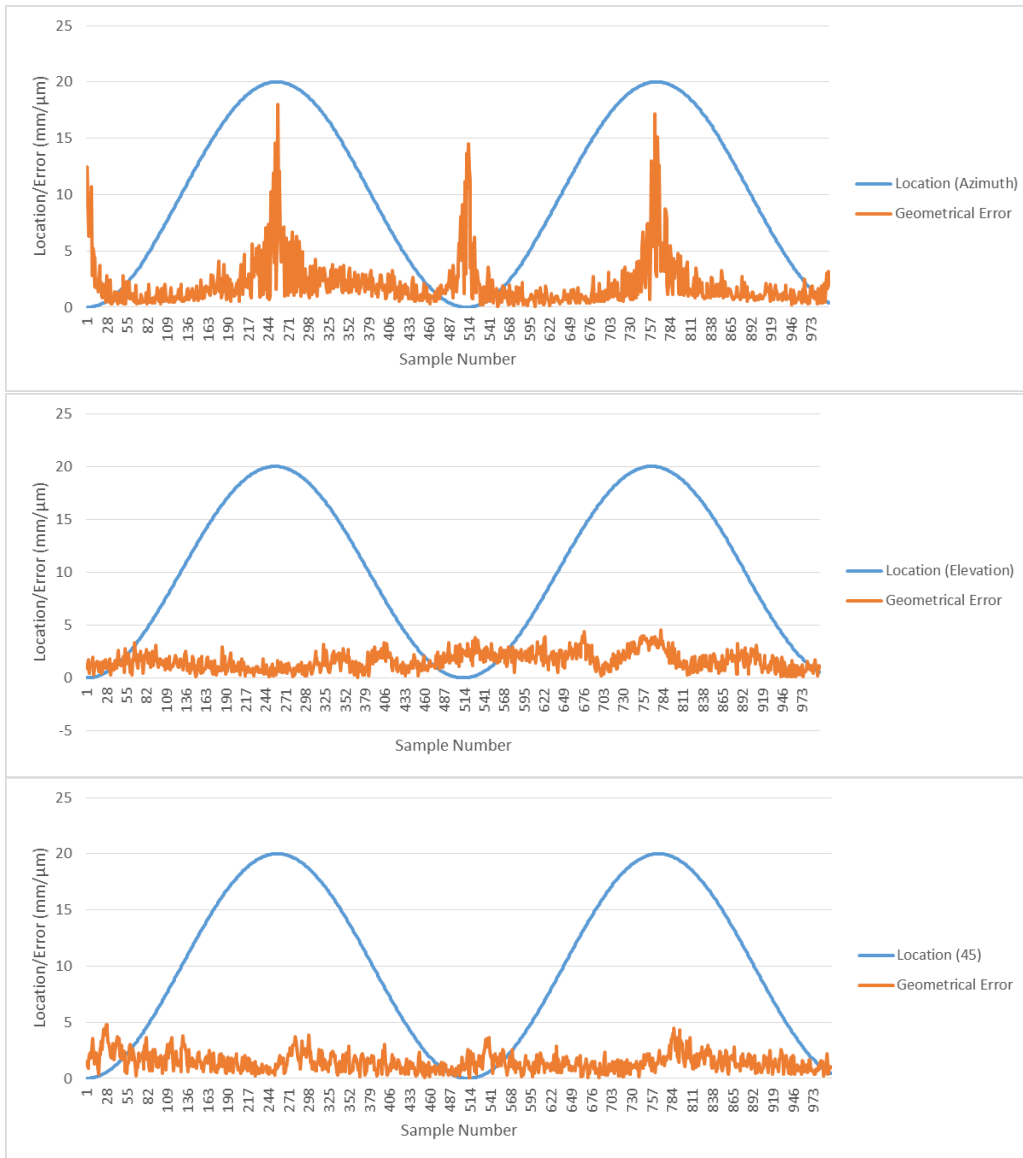

Figure 41: Geometric deviation results from the FARO tracker

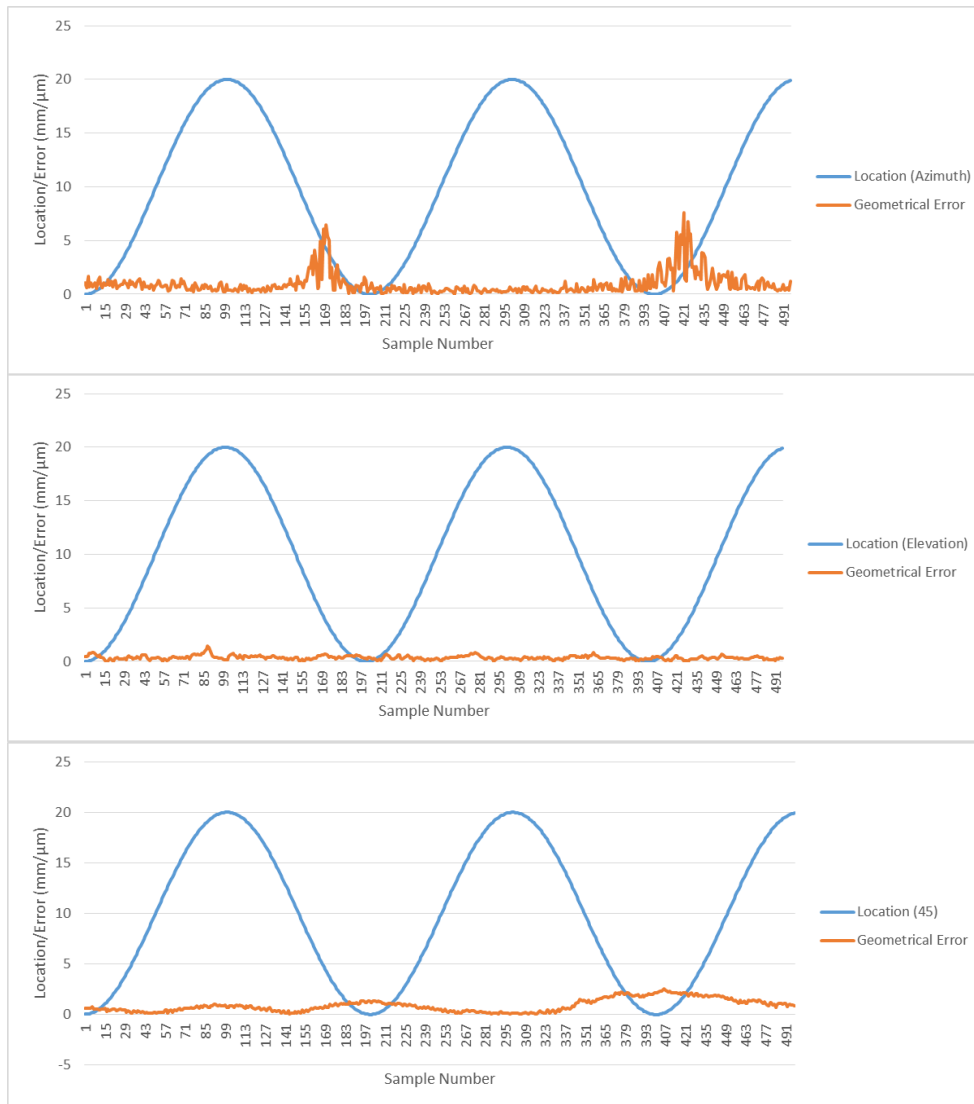

Figure 42: Geometric deviation results for the Leica tracker

Table 9: Geometric deviation RMS errors for each tracker in μm

	API	FARO	Leica
Azimuth	2.537	2.981	1.395
Elevation	2.933	1.803	0.456
45	6.936	1.646	1.734

The first thing that is noticeable is that all three trackers exhibit a very different range of RMS errors. The API shows the highest errors. The API tracker also has the highest amount of rotating mass so this may be a possible explanation. The Leica, again,

shows higher error in the azimuth than the elevation. The mass or the rotating parts once again correlates with this result. The FARO is the only tracker that does not show a higher error when the axes are combined. The process used to compensate for the encoder combination may be better in the FARO than the other two trackers. The range of results shows that this is a viable way to evaluate scanning accuracy.

CHAPTER 7: ARTIFACT SCAN

7.1 Introduction

A common evaluation for scanning devices uses a certified artifact to evaluate the capability to identify form. For this particular test, a form artifact was not available so an object scanned by a certified non-contact scanner is used to observe the scanning function of the tracker in comparison to a three point measurement as well as the fit from the high-density measurement from the scanner.

7.2 Equipment

The FARO scanner was used for this comparison. The test piece was a formed and punched sheet metal piece. The scan used for comparison was done by and ATOS TS III. The blue light scanner is certified to be accurate to for within 15 micrometer in an ideal VDI evaluation.

7.3 Setup

The test piece was scanned by the ATOS system and a mesh for the part was established using a Gaussian fit.

The scan done by the FARO tracker was done with the part secured to a surface and a 1.5 inch SMR, some features directly with the sphere and some using the pin nest. All proper equipment offsets were accounted for in the scan settings.

7.4 Procedure

The part was first scanned using the ATOS TSII for a nominal comparison. Multiple exposures were taken to map the surface for a full-coverage, non-contact scan. The scan was analyzed in ATOS Professional V8 software. The collected data was converted to a mesh and the features selected for comparison were fit using a Gaussian best fit within the software. The diameter values of the holes were determined.

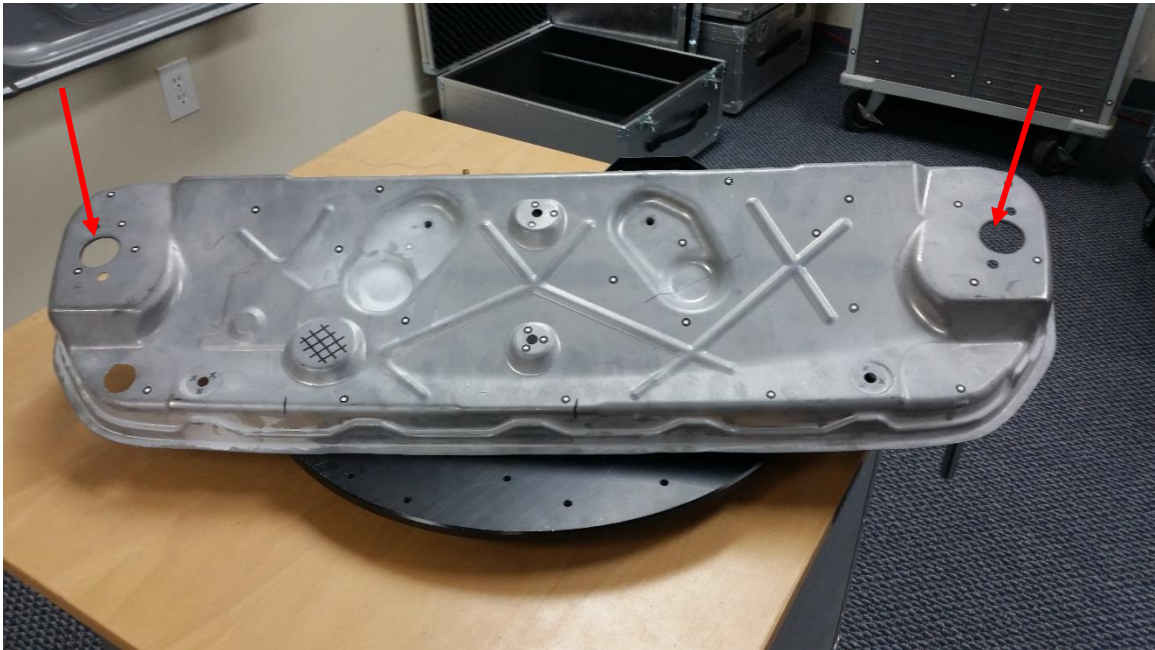

Figure 43: Artifact for scanning with holes highlighted

The part was then scanned using the FARO tracker. The SMR was placed on a pin nest to measure the radius of the holes and was scanned in direct contact for surface form characteristics. The holes were also measured using static point measurements in four locations to establish a circular fit in the software. A good measuring practice is to gather more but in this case four are used to demonstrate a worst case scenario. The SMR and nest were accounted for in the software. The geometries were best fit in Spatial Analyzer. The numbers from the holes were reported for comparison.

Other features measured by the FARO were taken to look at some characteristics of the part. The geometries are irregular and difficult to compare but are shown to demonstrate the capability of the tracker in scan mode versus static point measurements.

7.5 Data and Analysis

7.5.1 Scanned Features

The scan performed mapped the features of the part. Figure 44 shows the distinct features that were scanned. The form of each shaped can be seen clearly in the scan. The two small circular holes shown are the holes being compared for form value.

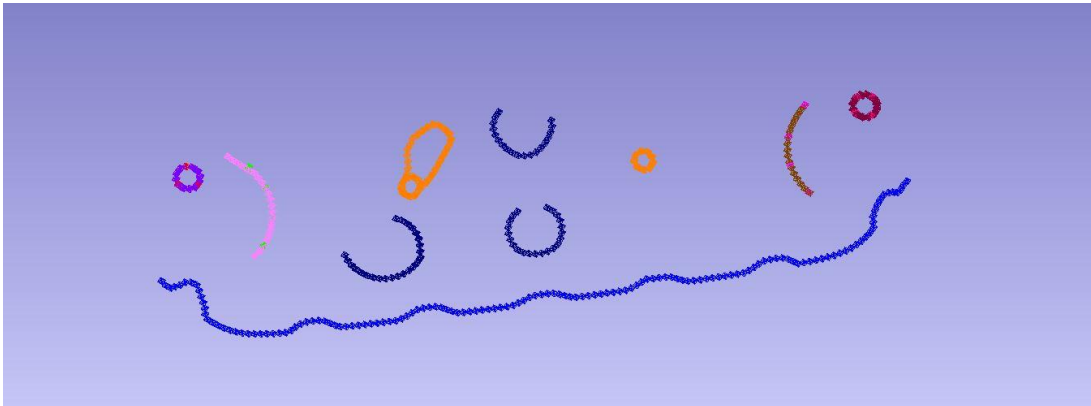

Figure 44: An image of the scan data from the features of the artifact

7.5.2 Static Point Fit

The first measurement done using the FARO was a simple four point measurement. The circle is fit to the four points as shown below in Figure 45. The two circles fit using

the static point measurement have the following dimension, the right circle has a diameter of 31.322 mm and the diameter of the left is 30.998 mm

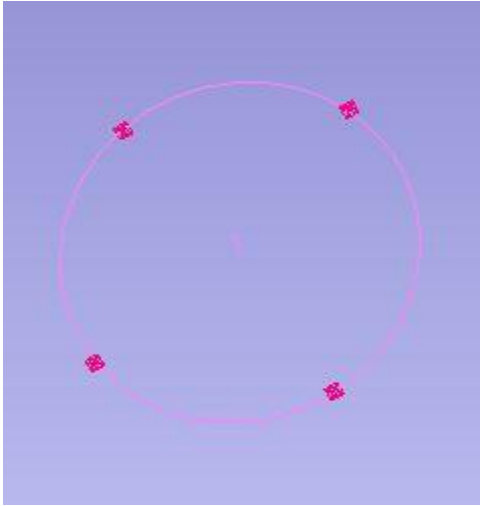

Figure 45: Four static points fit to a circle

7.5.3 Dynamic Scan Fit

The next measurement performed was a scan of the same two circles. The fit for the scan is shown in Figure 46. The diameter value for the right hole is 31.515 mm and the left is 31.176 mm.

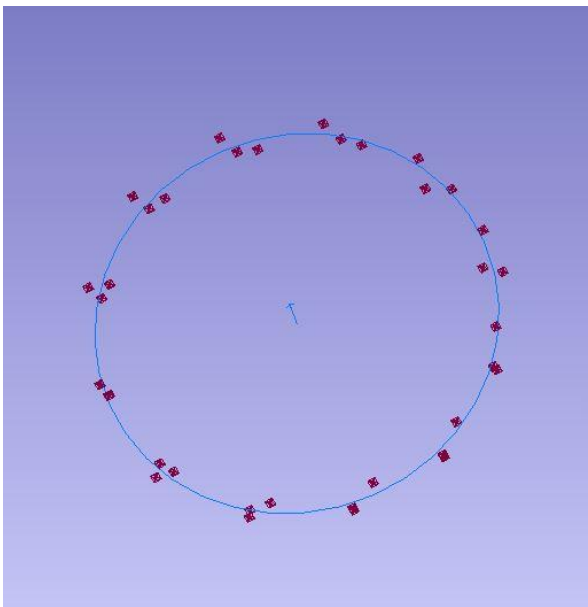

Figure 46: Dynamic scan data best-fit to a circle

7.5.4 Nominal Data from ATOS Scanner

The scan done on the ATOS collected the data over the entire surface and allows for geometry fitting once the scanned points are collected and converted to a mesh. The results from the scan are shown below in Figure 47. The diameter of the right and left holes are shown to be 31.67 mm and 31.30 mm respectively, are the nominal values used.

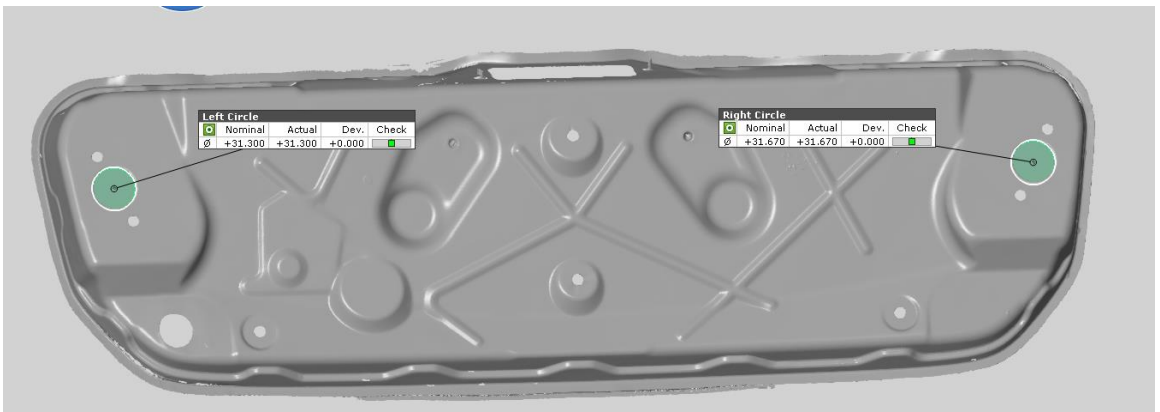

Figure 47: ATOS scan of sheet metal with hole diameter values

7.5.6 Comparison

The values below in Table 10 show all of the diameter values with the error values to the nominal scan diameter. The error for the static measurement are over twice that of the dynamic measurement. Though individual points in scanning function is subject to more errors, the density of the data set overcomes that when the points are averaged for feature evaluation. The results from the scan show that, though the points in the static scan lie on the circle, having a larger number of the points from the scan will result in a better fit when averaged.

Table 10: Diameter values for scan configurations with error from nominal scan (in mm)

	Nominal Scan	Static Scan (error)	Dynamic Scan (error)
Left	31.3	30.998 0.302	31.176 0.124
Right	31.67	31.322 0.348	31.515 0.155

CHAPTER 8: CONCLUSIONS AND FUTURE WORK

8.1 Discussion of Evaluation Variables

8.1.1 SMR Speed

The speed of the SMR when scanning has indicated a direct relationship with uncertainty. When examining the results based exclusively on speed of object being tracked, the three trackers show distinct error ranges but all show an increased error with increased speed. The root cause of the error cannot be identified based solely on the variation of speed. Something to consider when considering speed as the source is the stability of the tracker itself. At increased velocities, a larger rotational mass may cause some instability of the position of the laser tracker. An unstable base may be the cause but whether it is considered part of the system is significant.

8.1.2 Distance from SMR to Tracker

The range of the measurement also reflects some additional uncertainty, although it does not appear to be due to the ranging axis itself. The ranging measurements, when isolated, demonstrate error ranges that are congruent with the certification ranges of the trackers as they are statically certified. There is, however an error trend in some cases showing a direct relationship. It is possible that the trend is due to the encoder rotation of the head. When the rotary encoders move at a shallower angle, it is possible that they are not as accurate. The ranges tested in the setups performed were not the full range of each tracker so extending the range variation will give a better idea of what is happening.

Static evaluations are done over the entire range of the tracker, as should dynamic evaluation.

8.1.3 Isolations of Tracker Axes

The azimuth and elevation of the trackers demonstrated a higher error when isolated than the ranging axis but the errors in the axes in each tracker did not demonstrate a direct relationship. The azimuth and elevation errors were not consistent with each other.

8.2 Comparison of Results

8.2.1 Individual Tracker Conclusions

The testing methods suggest that the dynamic operation is affected by the investigated variables including target speed, encoder velocity, and range.

8.2.2 Tracker to Tracker Comparisons

In testing setups where more than one tracker was used, significant variations occurred from tracker to tracker. Due to the variations between them in identical setups, some variation of the procedures used may be a basis for a standardized comparison.

The distinct differences in the data collected in the rotational ball bar setup demonstrate that each model of tracker has its own distinct error sources that must be accounted for. The standard should include methods relevant and encompassing to all models and designs. The difference in the location of laser origination, the rotational mass, and the aiming mechanism are just some of the design variations unique to each tracker that has been shown to impact the accuracy.

8.3 Additional Considerations

Among the variable considered above, many things must also be accounted for when considering the comparison. Equipment, such as brand specific SMR kits and stands, is something that must be considered. Because the tracker is expected to be location-constant, the environment should also be as stable as possible when considering vibration. Any displacement of the tracker itself may go undetected and increase the error. The vibrational sensitivity of the trackers may be significant and should be investigated further.

CHAPTER 9: RECOMMENDATIONS FOR REVISION TO STANDARD

9.1 Current Standard

The current standard is designed for static measurement. It thoroughly evaluates the tracker to artifacts in a point to point measurement. The measurements are taken of traceable reference lengths at specified distance intervals along the entire range of the tracker. A two-face test, two measurements of the same point taken a full rotation of the tracker head apart, is performed to evaluate repeatability throughout the range of the rotary axes. A third procedure is performed to evaluate the ranging axis using the ADM and the interferometry modes. The standard, as mentioned, does nothing to address the dynamic capabilities of the tracker.

9.2 Recommendations

The above investigation has given some insight into the scanning capabilities of a laser tracker. Based on the insight there is a definite need for a standard to establish a certifiable scanning capability. The following are some basic recommendations to consider in developing a standard.

9.2.1 Ranging Axis

The ranging axis on the tracker appears to be the most stable throughout testing, however it is still essential to evaluate it for dynamic functionality. Based on the results seen in testing, a certified precision slide may be an effective method. If possible, a

longer slide would give a more reliable result. Using a slide closer to a meter in length may be beneficial. Testing from distances throughout the range would also be beneficial. For any evaluation involving a laser, the environment for certification should be controlled. The temperature, humidity and air contaminants should be minimized to manufactures standards to avoid interference with the laser. Using a mirror, the tracker can isolate the measurement to exclusively consider the direct line from the target to the tracker without any motion in the rotary axes. The displacement could be measured with an interferometer with known uncertainty for a comparison. Both the IFM and the ADM functions should be evaluated.

9.2.2 Rotary Axes

The two rotary axes should be evaluated as well by isolation. Using a setup similar to those seen in chapter 6, the two axes can be separated. By separating them it is possible to find the greatest uncertainty in each. Again, the testing range should be lengthened and should be aligned to measure purely in one axis. The axes should also be investigated at different speeds.

9.2.3 Rotational Velocity

Based on the results from the rotating ball bar in chapter 5, a similar setup could be used to determine the error in motion. Additional tests would be beneficial. Bars of various certified lengths could be used. The tracker should be put at intervals along the range. At each position, a ball bar of a certified length should be rotated with identical SMRs at each end. Both ends should be measured to account for any off-center mounting. It may be beneficial to use multiple bars of different lengths. Each location and bar should be measured at increasing intervals of rotational speed. The tracker should be

aligned so that the tracker head and ball bar rotate in parallel planes and the distance from the tracker to the cube corner remains constant, removing the ranging uncertainty. Other alignments of the tracker should also be considered if the tracker or ball bar assembly can be rotated horizontally. Using ball bars of carbon fiber or a low CTE, high stiffness material can negate the effects of temperature and gravitational effects.

The setup can help determine the error range as well as the capabilities of the tracker. Trackers in the study have demonstrated that not all models have the same range of capabilities. The results of the evaluation make it possible to specify uncertainty over the range of the tracker and at different speeds. The ability of the tracker to perform at the full range and speed should also be noted to establish performance limitations.

9.2.3 Artifact Scan

Another option is an artifact scan. Scanning a certified artifact, the results can determine the error of the system in a realistic scanning situation. Nests could be mounted on the artifact for comparison to a static measurement. The issues with this process are the introduction of human errors. The uncertainty of the SMR is a known value but an artifact scan requires manual operation.

When scanning an artifact, a procedure should be followed for a form comparison. Scanning software comes with various options when fitting data to shapes. The use of a sphere or even a circle with a pin nest would give a basis for comparison to a documented for value for a known artifact.

9.2.4 General Guidelines for Testing

After working with the various trackers, there are some guidelines that should be followed to ensure the fairest, most accurate assessment.

First, as always, is the environment. If the temperature of the environment is not regulated, it should be compensated for using a weather station or manually in data processing. The air quality and humidity should also be considered greatly. If the application of the tracker is in a non-ideal environment, the accuracy can be impacted. The manufactured certification may not be accurate to the environment that the tracker operates in and should be considered.

Another consideration is the non-tracker equipment in the system. The stand that holds the tracker is very significant. Using a less robust base can increase the vibration in the tracker. Any accessory kit used in measurement also has an uncertainty associated with it. The use of these, such as edge finders and pin nests, is common and often necessary but can result in added system error. When certifying the system to a standard, defining what tools are part of the system may be relevant.

Repetition of testing is common and can be useful for reducing outliers in the measurement. Multiple data sets can identify regularity and irregularity in the system. The repeatability may also be assessed this way.

The software is another factor that leaves a lot to consider. Every software does not operate the same. When completing comparisons, the method for data analysis should be specified. Things such as best-fit method and data filtering can be done in a variety of ways and should be specified. Integration of the certification into software is a possibility if the fits designated are commonly used in software packages.

REFERENCES

- American Society of Mechanical Engineers. 2006. "ASME B89.14.19-2006, Performance Evaluation of Laser-Based Coordinate Measurement Systems." New York, November 30.
- Bridges, Bob. 2009. "How Laser Trackers Work." *Quality Digest*. June 25.
- Calkins, Joseph M., and Robert J. Salerno, PhD. 2000. "A Practical Method for Evaluating Measurement System Uncertainty." *Boeing Large Scale Metrology Conference*. Long Beach, CA.
- Clark, T. A., X. Wang, A. B. Forbes, and N. R. Cross. 2000. "The case for a consistent method of verifying the performance of large volume metrology systems." *Co-ordinate Measurement Systems Committee Conference*. UK.
- Estler, W. T., K. L. Edmundson, G. N. Peggs, and D. H. Parker. 2002. "Large-Scale Metrology - An Update." *CIRP Annals - Manufacturing Technology*, v51 n2 587-609.
- Jianfei, Ouyang, Liang Zhiyong, Zhang Haixin, and Yan Yonggang. 2006. "Research of measuring accuracy of laser tracker systems." *Proc. of SPIE vol. 6280*. China.
- Lau, K., R. J. Hocken, and W. C. Haight. 1986. "Automatic laser tracking interferometer system for robot metrology." *Precision Engineering* 3-8.
- Tullar, Paul, John Grant, John Patten, and Robert Hocken. 1990. *Error Modeling and Correction of a Laser Tracker*. Technical Report, Charlotte, NC: UNC Charlotte.